[Preparations](#)

[Parts and Controls](#)

[Basic Operations](#)

[Connections](#)

[Other Operations](#)

[Apps](#)

[Announcements](#)

Xperia™ Tablet S SGPT12/SGPT13 Series

Help Guide

This Help guide is for Android version 4.0.3 (release6).

[Checking the Android Version](#)[Updating Android to the Latest Version](#)[Read This First](#)[Using the Home Screen](#)[List of Apps](#)

[Language Selection](#)

[English](#)[Français](#)

You can download the Help guide (PDF file) to the tablet device and view it whenever you want [\[Details\]](#). After downloading, select “helpguide_pdf.pdf” with the Downloads app.

[Download Help guide \(PDF file\)](#)

[▶ Troubleshooting](#)[Preparations](#)[Parts and Controls](#)[Basic Operations](#)[Connections](#)[Other Operations](#)[Apps](#)[Announcements](#)

Preparations

[Account](#)[Battery](#)[Display](#)[Home](#)[Keyboard](#)[Power](#)[Settings](#)[Supplied items](#)[Version](#)[Wi-Fi](#)[Wireless WAN](#)[Apps](#)[Battery charge](#)[Download](#)[Internet](#)[Main unit](#)[Read this first](#)[Specifications](#)[Text input](#)[WPS](#)[Widgets](#)

▶ [Troubleshooting](#)

Preparations

Parts and Controls

Basic Operations

Connections

Other Operations

Apps

Announcements

Parts and Controls

[Main unit](#)

[▶ Troubleshooting](#)

Preparations

Parts and Controls

Basic Operations

Connections

Other Operations

Apps

Announcements

Basic Operations

[Account](#)

[Battery](#)

[Browser](#)

[Data transfer](#)

[Download](#)

[Home](#)

[Keyboard](#)

[Memory space](#)

[Photos](#)

[Remote control](#)

[Search](#)

[Settings](#)

[Wi-Fi](#)

[Apps](#)

[Battery charge](#)

[Calculator](#)

[Display](#)

[E-mail](#)

[Internet](#)

[Lock](#)

[Music](#)

[Power](#)

[Reset](#)

[Security](#)

[Text input](#)

[Widgets](#)



▶ [Troubleshooting](#)

Preparations

Parts and Controls

Basic Operations

Connections

Other Operations

Apps

Announcements

Connections

[Bluetooth](#)

[Data transfer](#)

[Internet](#)

[Settings](#)

[USB](#)

[Wi-Fi](#)

[Computer](#)

[HDMI](#)

[Main unit](#)

[Television](#)

[WPS](#)

[Wireless WAN](#)

[▶ Troubleshooting](#)

[Preparations](#)

[Parts and Controls](#)

[Basic Operations](#)

[Connections](#)

[Other Operations](#)

[Apps](#)

[Announcements](#)

Other Operations

[Account](#)[Battery](#)[Bluetooth](#)[Browser](#)[Calendar](#)[Computer](#)[Data transfer](#)[Dock Speaker](#)[E-mail](#)[HDMI](#)[Initialization](#)[Memory space](#)[Music](#)[Power](#)[Remote control](#)[SD Memory card](#)[Security](#)[Synching](#)[USB](#)[Wi-Fi](#)[Backup](#)[Battery charge](#)[Books](#)[Calculator](#)[Clock](#)[Contacts](#)[Display](#)[Download](#)[GPS](#)[Home](#)[Lock](#)[Movies](#)[Photos](#)[Registration](#)[Reset](#)[Search](#)[Settings](#)[Television](#)[Version](#)

[▶ Troubleshooting](#)

Preparations

Parts and Controls

Basic Operations

Connections

Other Operations

Apps

Announcements

Apps

[Account](#)

[Browser](#)

[Calendar](#)

[Clock](#)

[Data transfer](#)

[Facebook](#)

[Internet](#)

[Memo](#)

[Music](#)

[Registration](#)

[SNS](#)

[Search](#)

[Videos](#)

[Books](#)

[Calculator](#)

[Clip](#)

[Contacts](#)

[E-mail](#)

[Games](#)

[List of apps](#)

[Movies](#)

[Photos](#)

[Remote control](#)

[Scrapbook](#)

[Twitter](#)

[▶ Troubleshooting](#)

[Preparations](#)

[Parts and Controls](#)

[Basic Operations](#)

[Connections](#)

[Other Operations](#)

[Apps](#)

[Announcements](#)

Announcements

[Account](#)[Battery charge](#)[Chat](#)[GPS](#)[Internet telephone](#)[Movies](#)[Power](#)[Reset](#)[Settings](#)[Trademarks](#)[Wi-Fi](#)[Battery](#)[Bluetooth](#)[Display](#)[Initialization](#)[Main unit](#)[Photos](#)[Read this first](#)[SD Memory card](#)[Specifications](#)[Version](#)[Wireless WAN](#)

Xperia™ Tablet S SGPT12/SGPT13 Series

Help Guide

See the following URL for detailed FAQs.

For customers in the U.S.:

<http://esupport.sony.com/model/SGPT121USS/US/>

For customers in Canada:

<http://esupport.sony.com/model/SGPT121CAS/CA>

For customers in Latin America (except Brazil):

<http://esupport.sony.com/model/SGPT121MXS/LA> (SGPT12)

<http://esupport.sony.com/model/SGPT131MXS/LA> (SGPT13)

For customers in Brazil:

<http://esupport.sony.com/model/SGPT131BRS/BR> (SGPT13)

Embedded Secure Document

The file http://esupport.sony.com/docs/tablet/helpguide_sgpt2_3/US/pdf/helpguide_pdf.pdf is a secure document that has been embedded in this document. Double click the pushpin to view.



[▶ Troubleshooting](#)

Preparations

Parts and Controls

Basic Operations

Connections

Other Operations

Apps

Announcements

Downloading the Help guide

You can download the PDF Help guide to your tablet device.

Install the Reader by Sony app or another PDF reader app to view the PDF file on your tablet device.



1. Tap “Download Help guide (PDF file)” from the top page of the Help guide.
2. After downloading the Help guide has finished and  appears on the status bar at the bottom right of the screen, tap the status bar.



The notification panel is displayed.

3. Tap “helpguide_pdf.pdf.”
Select and tap an application with which to view the PDF file, and the Help guide will be displayed.

Hint

- You can also display the Help guide by tapping [ Apps & Widgets] - [ Downloads] and selecting “helpguide_pdf.pdf.”

Related Topic

[Searching for Apps](#)

[Confirming Download or Update Information on the Status Bar](#)

[▶ Troubleshooting](#)

[Preparations](#)

[Parts and Controls](#)

[Basic Operations](#)

[Connections](#)



[Other Operations](#)

[Apps](#)

[Announcements](#)

Checking the Android Version

You can confirm the version of the Android operating system running on your tablet device.

1. Tap [ Apps & Widgets] - [ Settings] - [About tablet].

You can check the version of Android running on your tablet device in [Android version].

Related Topic

[Updating Android to the Latest Version](#)

[▶ Troubleshooting](#)

[Preparations](#)

[Parts and Controls](#)

[Basic Operations](#)

[Connections](#)

[Other Operations](#)

[Apps](#)

[Announcements](#)

Updating Android to the Latest Version

Update your tablet device to the latest version of Android when updates become available.

Note

- Once you have updated, you cannot return your tablet device to an older version of Android. Updating requires the remaining battery level to be at 50% or greater and use of the AC adapter. Your tablet device may no longer turn on if the battery is depleted while updating.
- The data stored on the internal storage (memory space in your tablet device) will not be erased by updating.
- There must be enough free space on the internal storage to download the update files when updating.
- Some applications may not be compatible with the updated version of Android, and they may no longer run after updating.
- Be sure to check the Android version that each application is compatible with before updating.
- Updating may take longer if you connect to the Internet using the mobile communications function. In addition, large data charges may be incurred depending on the service you subscribe to. (SGPT13)

1. Tap [ Apps & Widgets] - [ Settings] - [About tablet].

2. Tap [System updates].

The screen to start updating is displayed when an update is available. Start updating by following the instructions on the screen.

Related Topic

[Checking the Android Version](#)

[▶ Troubleshooting](#)

[Preparations](#)

[Parts and Controls](#)

[Basic Operations](#)

[Connections](#)

[Other Operations](#)

[Apps](#)

[Announcements](#)

Read This First

This Help guide is for Android version 4.0.3 (release6).

Congratulations on your purchase of a Xperia(TM) Tablet S.

Before you start using your tablet device, read the supplied Important Information (safety instructions). This Help guide explains how to operate your tablet device and apps. You can download the Help guide (PDF file) to the tablet device [\[Details\]](#).

Charging the battery

The battery charge level may be low when you purchase your tablet device. Charge the battery before you start using your tablet device [\[Details\]](#).

About software (Android version) updates

When you update the software (Android version), be sure to install the latest version of each app. Otherwise, some apps may not start. To find a newer version of apps, check Play Store [\[Details\]](#).

About Google account

Having a Google account enables you to use Google services such as Google Play Store (free registration).

Using a Google account, you can sync Google services you use on your computer, or other devices with apps on the tablet device such as mail, calendar and user applications [\[Details\]](#).

Note

- Some models are not available in some countries/regions.

Related Topic

[Downloading the Help guide](#)

[Charging the Battery](#)

[Configuring a Google Account](#)

[Checking the Android Version](#)

[Searching for Apps](#)

▶ Troubleshooting

Using the Home Screen

The Home screen consists of five separate screens. You can customize screens to fit your needs by placing your favorite apps and widgets on the screens.



A: Google search
Tap the box to easily search with Google.

B: Quick launcher
The Quick launcher is displayed on every page of the Home screen, so registering apps you use often gives you quick access to them.

1. Tap and hold an icon on the Home screen, and then drag it into the Quick launcher.

Hint

- You can move icons within Quick launcher, and move them out of the Quick launcher.

C:  Guest Mode

Tap this to use Guest Mode for sharing the tablet device with other users such as your family or friends.

D:  Apps & Widgets

Tap this to display the apps list and the widgets list.

E: Widgets

Widgets are simple apps running on the Home screen. You can choose your favorite widgets from the widgets list and place them on the Home screen.

F: Apps

You can choose your favorite apps from the apps list and place them on the Home screen.

G: Basic operation buttons

Preparations

Parts and Controls





Basic Operations

Connections

Other Operations

Apps

Announcements

-  (Back): Tap this to return to the previous screen.
-  (Home): Tap this to display the Home screen.
-  (Recent Apps): Tap this to display the apps used recently.
- : Tap this to hide the keyboard when the keyboard is displayed.

H: Small Apps

You can open small versions of certain apps, such as the browser, calculator, and remote control, even while another app is in use.

I: Status bar

The status bar displays the remaining battery level and Wi-Fi connection icons. Notification icons are also displayed to tell you that downloading is complete, you have e-mails, or updates are available. By tapping the status bar, you can display the notification panel and control panel.

Related Topic

[Searching with Google](#)

[Sharing the Tablet Device with Family or Friends \(Guest Mode\)](#)

[Using the Apps & Widgets List](#)

[Confirming Download or Update Information on the Status Bar](#)

[Using “Small Apps”](#)

[▶ Troubleshooting](#)

[Preparations](#)

[Parts and Controls](#)

[Basic Operations](#)

[Connections](#)

[Other Operations](#)

[Apps](#)

[Announcements](#)

List of Apps

The following apps are preinstalled on your tablet device. You can start each app by tapping its icon.

Hint

- When  (Option menu) appears at the top right of the screen, you can tap it to display the option menu.



Calendar

Manage your schedule and synchronize the schedule with Google Calendar [\[Details\]](#).



Browser

Browse Internet websites [\[Details\]](#).



Camera

Shoot photos or movies [\[Details\]](#).



People

Manage contacts for your friends or colleagues [\[Details\]](#).



Desk clock

Display the current time [\[Details\]](#).



Email

Send or receive PC e-mail messages [\[Details\]](#).



Movies

Play back movie files [\[Details\]](#).



Play back music files [\[Details\]](#).



View photos [\[Details\]](#).



Browse or edit photos [\[Details\]](#).



Import/export data between SD memory card/USB storage and the internal memory of the tablet device [\[Details\]](#).



Use your tablet device as a remote control [\[Details\]](#).



Check the latest news, blogs and posts on Facebook and Twitter all in one app [\[Details\]](#).



Check the connection status and hints for troubleshooting Wi-Fi (wireless LAN) [\[Details\]](#).

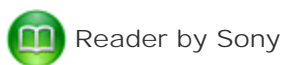

Purchase and browse eBooks [\[Details\]](#).

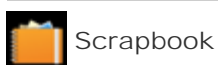

Put your memos and pictures in a scrapbook [\[Details\]](#).



Display this Help guide online. You can download it to the tablet device [\[Details\]](#).



Start Up Guide

Instructions for basic operations of the tablet device, how to connect to Internet, etc.



Support

Access the Sony customer support website.



Sony Select

Access a website that introduces Sony-recommended apps [\[Details\]](#).



Registration *¹

Register your tablet device with Sony [\[Details\]](#).



Product registration

Register your tablet device with Sony [\[Details\]](#).



Video Unlimited *¹

Access Sony's premium video delivery service [\[Details\]](#).



Music Unlimited *¹

Access Sony's cloud music delivery service [\[Details\]](#).



PlayMemories Online *¹

Enjoy your photos and videos across your favorite devices, instantly! [\[Details\]](#)



Xperia Link

Internet connection from your tablet by using smartphone [\[Details\]](#).



Access PlayStation(R)Store, and manage or run content purchased from the store [\[Details\]](#).

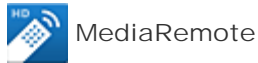

Control Sony devices supporting the MediaRemote app via the Wi-Fi network [\[Details\]](#).



Change various settings of your tablet device [\[Details\]](#).

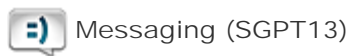

Send or receive SMS (short messages).

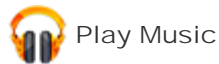

Play back music.

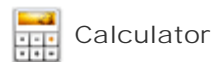

Make basic calculations [\[Details\]](#).



Send or receive Gmail [\[Details\]](#).



Make Google searches [\[Details\]](#).



Access the Google+ social networking service provided by Google.



Exchange instant messages with other Google+ users.

 Play Movies *1

Play back movies you have rented from Google Play.

 Maps

Find your location and search destinations/routes (Google Maps).

 Local

Use this service to find information on shops and places.

 Navigation

Use this Internet-aided GPS navigation system that includes a voice guidance function.

 Latitude

Find out where your friends are on a map.

 Talk

Chat by text/voice and make video calls (Google Talk).

 Play Store

Download or purchase new apps and update apps [\[Details\]](#).

 YouTube

Video sharing service.

 Play Books *1

Search and preview a wide range of books from libraries and publishers all over the world.

 Downloads

Use the download manager to display or manage Internet content downloads.



Use a free translation service widely employed around the world that enables you to translate many languages instantly.



Store and sync files to access your data from anywhere using various devices.



Easily edit/store movies from your movies and photos.



View full-length and full-size Hollywood movies and TV programs [\[Details\]](#).



Zinio is the premier app for magazines on your tablet, giving readers immediate access to thousands of global titles [\[Details\]](#).



Evernote turns your tablet into an extension of your brain. Evernote is a free app that helps you remember everything across all of your tablet [\[Details\]](#).



Make free voice and video calls to anyone else on Skype, whether they're on an Android or PC, as well as IMs to your friends and family [\[Details\]](#).



View and share Microsoft Word, Excel, and PowerPoint and PDF files and attachments on your tablet with a single complete feature-rich mobile Office solution [\[Details\]](#).



AccuWeather forecasts for 2.7 million locations, supports 27 languages, and has descriptive weather graphics that will appeal to your tablet [\[Details\]](#).



Download high quality games to your Android tablet from the Top HD Games at Gameloft's online store [\[Details\]](#).



The Xperia Games blog is your source for all the latest games news on your Xperia(TM) Phone or Xperia(TM) Tablet S [\[Details\]](#).

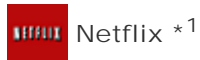

Netflix is the world's leading subscription service for watching TV episodes and movies on your tablet. The Netflix application is designed to deliver the best experience on your tablet anywhere, anytime [\[Details\]](#).



Hulu Plus. Unlimited Instant Streaming (Subscription Required).

Download the app to enjoy unlimited instant streaming of current hit TV shows with your Hulu Plus subscription. New to Hulu Plus? Try it FREE [\[Details\]](#).

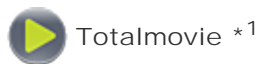

Totalmovie is the first service of streaming in Latin America. With Totalmovie you can watch full-length Movies, TV Series and much more [\[Details\]](#).



Watch movies as many times as you want and when you want. Download the NetMovies app for FREE [\[Details\]](#).

*1 Apps or services may not be available in some countries/regions.

Video Guide

[Preparations](#)

[Parts and Controls](#)

[Basic Operations](#)

[Connections](#)

[Other Operations](#)

[Apps](#)

[Announcements](#)

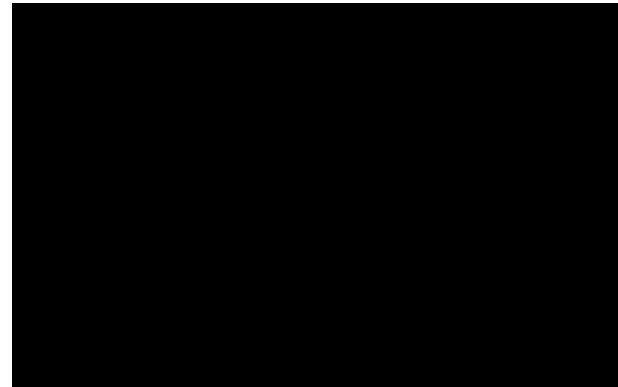

[Guest Mode](#)

[Small Apps](#)

[Album and Movies](#)

[Registering the Remote Control](#)

[Programming Operations in the Remote Control \(Macro Function\)](#)

[Using "Small Apps"](#)

[Remote-control](#)

[Related Topic](#)

[Sharing WALKMAN](#)

[the Tablet Device with Family or Friends \(Guest Mode\)](#)

[Open the help for the app](#)

[WALKMAN](#)

[Album](#)

[Movies](#)

[▶ Troubleshooting](#)[Preparations](#)[Parts and Controls](#)[Basic Operations](#)[Connections](#)[Other Operations](#)[Apps](#)[Announcements](#)

Account

[Configuring a Google Account](#)

You might be looking for the following topics:

[Configuring an E-mail Account](#)[Reverting to Factory Default \(Initializing Data\)](#)[Synchronizing the Account](#)

[▶ Troubleshooting](#)[Preparations](#)[Parts and Controls](#)[Basic Operations](#)[Connections](#)[Other Operations](#)[Apps](#)[Announcements](#)

Battery

[Adjusting the Screen Brightness](#)[Charging the Battery](#)[Setting the Time that Elapses Before the Screen Turns Off \(Goes to Sleep\)](#)[Specifications](#)

You might be looking for the following topics:

[Changing the Settings](#)[How to Maintain Battery Life](#)[Notes on Charging](#)[Notes on Using the AC Adapter](#)

[▶ Troubleshooting](#)[Preparations](#)[Parts and Controls](#)[Basic Operations](#)[Connections](#)[Other Operations](#)[Apps](#)[Announcements](#)

Display

[Adding Apps or Widgets to the Home Screen](#)[Adjusting the Screen Brightness](#)[Setting the Time that Elapses Before the Screen Turns Off \(Goes to Sleep\)](#)[Turning the Screen On/Off \(Sleep Mode\)](#)[Using the Home Screen](#)

You might be looking for the following topics:

[Changing the Settings](#)[Configuring Screen Rotation](#)[Configuring to Lock the Screen](#)[Notes on the Screen](#)[Sharing the Tablet Device with Family or Friends \(Guest Mode\)](#)[Switching to Guest Mode](#)[Touch Screen Operations](#)

[▶ Troubleshooting](#)[Preparations](#)[Parts and Controls](#)[Basic Operations](#)[Connections](#)[Other Operations](#)[Apps](#)[Announcements](#)

Home

[Adding Apps or Widgets to the Home Screen](#)[Using the Apps & Widgets List](#)[Using the Home Screen](#)

You might be looking for the following topics:

[Confirming Download or Update Information on the Status Bar](#)[Searching with Google](#)[Sharing the Tablet Device with Family or Friends \(Guest Mode\)](#)[Switching to Guest Mode](#)[Touch Screen Operations](#)[Using “Small Apps”](#)



▶ [Troubleshooting](#)

Preparations

Parts and Controls

Basic Operations

Connections

Other Operations

Apps

Announcements

Keyboard

[Entering Text](#)

[Selecting Text](#)

[▶ Troubleshooting](#)[Preparations](#)[Parts and Controls](#)[Basic Operations](#)[Connections](#)[Other Operations](#)[Apps](#)[Announcements](#)

Power

[Charging the Battery](#)[Turning On or Shutting Down Your Tablet Device](#)[Turning the Screen On/Off \(Sleep Mode\)](#)

You might be looking for the following topics:

[Resetting Your Tablet Device](#)

[▶ Troubleshooting](#)[Preparations](#)[Parts and Controls](#)[Basic Operations](#)[Connections](#)[Other Operations](#)[Apps](#)[Announcements](#)

Settings

[Checking the Android Version](#)[Connecting by Pressing the WPS Button on the Wi-Fi Router](#)[Connecting from the Wi-Fi Network List](#)[Connecting to Wi-Fi](#)[Setting the Time that Elapses Before the Screen Turns Off \(Goes to Sleep\)](#)[Turning On/Off the Wi-Fi Function](#)[Updating Android to the Latest Version](#)

You might be looking for the following topics:

[Changing the Settings](#)[Checking the Free Space](#)[Configuring Screen Rotation](#)[How to Maintain Battery Life](#)[Pairing with a Bluetooth Device](#)[Synchronizing the Account](#)[Turning On/Off the Bluetooth Function](#)[Using Location Services](#)



[▶ Troubleshooting](#)

Preparations

Parts and Controls

Basic Operations

Connections

Other Operations

Apps

Announcements

Supplied items

[Checking the Supplied Items](#)



▶ Troubleshooting

Preparations

Parts and Controls

Basic Operations

Connections

Other Operations

Apps

Announcements

Version

[Checking the Android Version](#)

[Updating Android to the Latest Version](#)

[▶ Troubleshooting](#)[Preparations](#)[Parts and Controls](#)[Basic Operations](#)[Connections](#)[Other Operations](#)[Apps](#)[Announcements](#)

Wi-Fi

[Checking the Wi-Fi Connection](#)[Connecting by Pressing the WPS Button on the Wi-Fi Router](#)[Connecting from the Wi-Fi Network List](#)[Connecting to Wi-Fi](#)[Specifications](#)[Turning On/Off the Wi-Fi Function](#)

You might be looking for the following topics:

[Notes on Holding Your Tablet Device](#)[Notes on Using the Wi-Fi Function](#)[Using Location Services](#)

[▶ Troubleshooting](#)[Preparations](#)[Parts and Controls](#)[Basic Operations](#)[Connections](#)[Other Operations](#)[Apps](#)[Announcements](#)

Wireless WAN

[Disabling Mobile Communications \(SGPT13\)](#)[Enabling Mobile Communications \(SGPT13\)](#)[Inserting/Removing a SIM Card \(SGPT13\)](#)[Setting Up an Access Point \(SGPT13\)](#)

You might be looking for the following topics:

[Notes on the SIM Card \(SGPT13\)](#)



▶ [Troubleshooting](#)

Preparations

Parts and Controls

Basic Operations

Connections

Other Operations

Apps

Announcements

Apps

[Using the Apps & Widgets List](#)

[▶ Troubleshooting](#)[Preparations](#)[Parts and Controls](#)[Basic Operations](#)[Connections](#)[Other Operations](#)[Apps](#)[Announcements](#)

Battery charge

Charging the Battery

You might be looking for the following topics:

[How to Maintain Battery Life](#)

[Notes on Using the AC Adapter](#)



▶ [Troubleshooting](#)

Preparations

Parts and Controls

Basic Operations

Connections

Other Operations

Apps

Announcements

Download

[Downloading the Help guide](#)

You might be looking for the following topics:

[Confirming Download or Update Information on the Status Bar](#)

[▶ Troubleshooting](#)[Preparations](#)[Parts and Controls](#)[Basic Operations](#)[Connections](#)[Other Operations](#)[Apps](#)[Announcements](#)

Internet

[Connecting to Wi-Fi](#)[Enabling Mobile Communications \(SGPT13\)](#)[Setting Up an Access Point \(SGPT13\)](#)[Turning On/Off the Wi-Fi Function](#)

You might be looking for the following topics:

[Accessing Sites from Bookmarks/Access History](#)[Adding Bookmarks](#)[Browsing Websites](#)



[▶ Troubleshooting](#)

Preparations

Parts and Controls

Basic Operations

Connections

Other Operations

Apps

Announcements

Main unit

[Parts and Controls](#)

You might be looking for the following topics:

[Notes on Use](#)

[Splash-proof Performance](#)



▶ [Troubleshooting](#)

Preparations

Parts and Controls

Basic Operations

Connections

Other Operations

Apps

Announcements

Read this first

[Read This First](#)

[▶ Troubleshooting](#)

Preparations

Parts and Controls

Basic Operations

Connections

Other Operations

Apps

Announcements

Specifications

[Specifications](#)



▶ [Troubleshooting](#)

Preparations

Parts and Controls

Basic Operations

Connections

Other Operations

Apps

Announcements

Text input

[Entering Text](#)

[Selecting Text](#)



▶ Troubleshooting

Preparations

Parts and Controls

Basic Operations

Connections

Other Operations

Apps

Announcements

WPS

[Connecting by Pressing the WPS Button on the Wi-Fi Router](#)



▶ [Troubleshooting](#)

Preparations

Parts and Controls

Basic Operations

Connections

Other Operations

Apps

Announcements

Widgets

[Using the Apps & Widgets List](#)

[▶ Troubleshooting](#)

Preparations

Parts and Controls

Basic Operations

Connections

Other Operations

Apps

Announcements

Main unit

[Parts and Controls](#)

You might be looking for the following topics:

[Notes on Use](#)

[Splash-proof Performance](#)

[▶ Troubleshooting](#)

[Preparations](#)

[Parts and Controls](#)[Basic Operations](#)

[Connections](#)

[Other Operations](#)

[Apps](#)

[Announcements](#)

Account

[Configuring a Google Account](#)[Configuring an E-mail Account](#)

You might be looking for the following topics:

[Reverting to Factory Default \(Initializing Data\)](#)[Synchronizing the Account](#)

[▶ Troubleshooting](#)

[Preparations](#)

[Parts and Controls](#)

[Basic Operations](#)

[Connections](#)

[Other Operations](#)

[Apps](#)

[Announcements](#)

Battery

[Adjusting the Screen Brightness](#)[Changing the Settings](#)[How to Maintain Battery Life](#)[Setting the Time that Elapses Before the Screen Turns Off \(Goes to Sleep\)](#)

You might be looking for the following topics:

[Charging the Battery](#)[Notes on Charging](#)[Notes on Using the AC Adapter](#)[Specifications](#)



▶ [Troubleshooting](#)

Preparations

Parts and Controls

Basic Operations

Connections

Other Operations

Apps

Announcements

Browser

[Accessing Sites from Bookmarks/Access History](#)

[Adding Bookmarks](#)

[Browsing Websites](#)

[Using “Small Apps”](#)

[▶ Troubleshooting](#)

[Preparations](#)

[Parts and Controls](#)[Basic Operations](#)

[Connections](#)

[Other Operations](#)

[Apps](#)

[Announcements](#)

Data transfer

[Checking the Free Space](#)[Supported Formats](#)

You might be looking for the following topics:

[Connecting a USB Compatible Device](#)[Connecting to a Computer](#)[Importing Content from Your Computer](#)[Importing/Exporting Contents from an SD Memory Card](#)[Inserting/Removing an SD Memory Card](#)[Pairing with a Bluetooth Device](#)[Playing Photos/Videos](#)[Sharing Photos/Videos](#)[Turning On/Off the Bluetooth Function](#)[Using "Media Go"](#)



[▶ Troubleshooting](#)

Preparations

Parts and Controls

Basic Operations

Connections

Other Operations

Apps

Announcements

Download

[Confirming Download or Update Information on the Status Bar](#)

[Downloading the Help guide](#)

[▶ Troubleshooting](#)

[Preparations](#)

[Parts and Controls](#)[Basic Operations](#)

[Connections](#)

[Other Operations](#)

[Apps](#)

[Announcements](#)

Home

[Adding Apps or Widgets to the Home Screen](#)[Confirming Download or Update Information on the Status Bar](#)[Searching with Google](#)[Sharing the Tablet Device with Family or Friends \(Guest Mode\)](#)[Switching to Guest Mode](#)[Touch Screen Operations](#)[Using the Apps & Widgets List](#)[Using the Home Screen](#)[Using “Small Apps”](#)



[▶ Troubleshooting](#)

Preparations

Parts and Controls

Basic Operations

Connections

Other Operations

Apps

Announcements

Keyboard

[Entering Text](#)

[Selecting Text](#)

[▶ Troubleshooting](#)

Preparations

Parts and Controls

Basic Operations

Connections

Other Operations

Apps

Announcements

Memory space

[Checking the Free Space](#)

[▶ Troubleshooting](#)

[Preparations](#)

[Parts and Controls](#)

[Basic Operations](#)

[Connections](#)

[Other Operations](#)

[Apps](#)

[Announcements](#)

Photos

Supported Formats

You might be looking for the following topics:

[Album](#)[Editing Photos](#)[Notes on Recorded Photos/Movies](#)[Playing Photos/Videos](#)[Sharing Photos/Videos](#)[Shooting Photos/Movies](#)[Using "Media Go"](#)

[▶ Troubleshooting](#)

[Preparations](#)

[Parts and Controls](#)

[Basic Operations](#)

[Connections](#)

[Other Operations](#)

[Apps](#)

[Announcements](#)

Remote control

[Using “Small Apps”](#)

You might be looking for the following topics:

[Programming Operations in the Remote Control \(Macro Function\)](#)

[Registering the Remote Control](#)

[Using Your Tablet Device as a Remote Control](#)

[Using “MediaRemote”](#)



▶ [Troubleshooting](#)

Preparations

Parts and Controls

Basic Operations

Connections

Other Operations

Apps

Announcements

Search

[Searching for Apps](#)

[Searching with Google](#)

You might be looking for the following topics:

[Using Sony Select](#)

[▶ Troubleshooting](#)

[Preparations](#)

[Parts and Controls](#)

[Basic Operations](#)

[Connections](#)

[Other Operations](#)

[Apps](#)

[Announcements](#)

Settings

[Changing the Settings](#)[Checking the Free Space](#)[Configuring Screen Rotation](#)[How to Maintain Battery Life](#)[Setting the Time that Elapses Before the Screen Turns Off \(Goes to Sleep\)](#)

You might be looking for the following topics:

[Checking the Android Version](#)[Connecting by Pressing the WPS Button on the Wi-Fi Router](#)[Connecting from the Wi-Fi Network List](#)[Connecting to Wi-Fi](#)[Pairing with a Bluetooth Device](#)[Synchronizing the Account](#)[Turning On/Off the Bluetooth Function](#)[Turning On/Off the Wi-Fi Function](#)[Updating Android to the Latest Version](#)[Using Location Services](#)

[▶ Troubleshooting](#)

[Preparations](#)

[Parts and Controls](#)

[Basic Operations](#)

[Connections](#)

[Other Operations](#)

[Apps](#)

[Announcements](#)

Wi-Fi

[Checking the Wi-Fi Connection](#)

You might be looking for the following topics:

[Connecting by Pressing the WPS Button on the Wi-Fi Router](#)[Connecting from the Wi-Fi Network List](#)[Connecting to Wi-Fi](#)[Notes on Holding Your Tablet Device](#)[Notes on Using the Wi-Fi Function](#)[Specifications](#)[Turning On/Off the Wi-Fi Function](#)[Using Location Services](#)



[▶ Troubleshooting](#)

Preparations

Parts and Controls

Basic Operations

Connections

Other Operations

Apps

Announcements

Apps

[Using the Apps & Widgets List](#)



[▶ Troubleshooting](#)

Preparations

Parts and Controls

Basic Operations

Connections

Other Operations

Apps

Announcements

Battery charge

[How to Maintain Battery Life](#)

You might be looking for the following topics:

[Charging the Battery](#)

[Notes on Using the AC Adapter](#)

[▶ Troubleshooting](#)

Preparations

Parts and Controls

Basic Operations

Connections

Other Operations

Apps

Announcements

Calculator

[Using “Small Apps”](#)

You might be looking for the following topics:

[Using the Calculator](#)

[▶ Troubleshooting](#)

[Preparations](#)

[Parts and Controls](#)

[Basic Operations](#)

[Connections](#)

[Other Operations](#)

[Apps](#)

[Announcements](#)

Display

[Adding Apps or Widgets to the Home Screen](#)[Adjusting the Screen Brightness](#)[Changing the Settings](#)[Configuring Screen Rotation](#)[Configuring to Lock the Screen](#)[Setting the Time that Elapses Before the Screen Turns Off \(Goes to Sleep\)](#)[Sharing the Tablet Device with Family or Friends \(Guest Mode\)](#)[Switching to Guest Mode](#)[Touch Screen Operations](#)[Turning the Screen On/Off \(Sleep Mode\)](#)[Using the Home Screen](#)

You might be looking for the following topics:

[Notes on the Screen](#)

[▶ Troubleshooting](#)

[Preparations](#)

[Parts and Controls](#)[Basic Operations](#)

[Connections](#)

[Other Operations](#)

[Apps](#)

[Announcements](#)

E-mail

[Composing/Sending an E-mail](#)[Configuring an E-mail Account](#)[Receiving/Deleting E-mails](#)

You might be looking for the following topics:

[Using "Gmail"](#)

[▶ Troubleshooting](#)

[Preparations](#)

[Parts and Controls](#)[Basic Operations](#)

[Connections](#)

[Other Operations](#)

[Apps](#)

[Announcements](#)

Internet

[Accessing Sites from Bookmarks/Access History](#)[Adding Bookmarks](#)[Browsing Websites](#)

You might be looking for the following topics:

[Connecting to Wi-Fi](#)[Enabling Mobile Communications \(SGPT13\)](#)[Setting Up an Access Point \(SGPT13\)](#)[Turning On/Off the Wi-Fi Function](#)



[▶ Troubleshooting](#)

Preparations

Parts and Controls

Basic Operations

Connections

Other Operations

Apps

Announcements

Lock

[Configuring to Lock the Screen](#)

[▶ Troubleshooting](#)

[Preparations](#)

[Parts and Controls](#)

[Basic Operations](#)

[Connections](#)

[Other Operations](#)

[Apps](#)

[Announcements](#)

Music

Supported Formats

You might be looking for the following topics:

[Setting the Audio Output Sound](#)[Using the “App Selector” with the tablet device attached to the Dock Speaker](#)[Using the “Music Unlimited” Music Delivery Service](#)[Using “Media Go”](#)[WALKMAN](#)

[▶ Troubleshooting](#)

[Preparations](#)

[Parts and Controls](#)[Basic Operations](#)[Connections](#)

[Other Operations](#)

[Apps](#)

[Announcements](#)

Power

[Resetting Your Tablet Device](#)[Turning On or Shutting Down Your Tablet Device](#)[Turning the Screen On/Off \(Sleep Mode\)](#)

You might be looking for the following topics:

[Charging the Battery](#)



[▶ Troubleshooting](#)

Preparations

Parts and Controls

Basic Operations

Connections

Other Operations

Apps

Announcements

Reset

[Resetting Your Tablet Device](#)

You might be looking for the following topics:

[Reverting to Factory Default \(Initializing Data\)](#)



▶ [Troubleshooting](#)

Preparations

Parts and Controls

Basic Operations

Connections

Other Operations

Apps

Announcements

Security

[Changing the Settings](#)

[Configuring to Lock the Screen](#)

[▶ Troubleshooting](#)

Preparations

Parts and Controls

Basic Operations

Connections

Other Operations

Apps

Announcements

Text input

[Entering Text](#)

[Selecting Text](#)



▶ [Troubleshooting](#)

Preparations

Parts and Controls

Basic Operations

Connections

Other Operations

Apps

Announcements

Widgets

[Using the Apps & Widgets List](#)

[▶ Troubleshooting](#)

[Preparations](#)

[Parts and Controls](#)

[Basic Operations](#)

[Connections](#)

[Other Operations](#)

[Apps](#)

[Announcements](#)

Bluetooth

[Pairing with a Bluetooth Device](#)[Turning On/Off the Bluetooth Function](#)

You might be looking for the following topics:

[Notes on Holding Your Tablet Device](#)[Notes on Using the Bluetooth Function](#)

[▶ Troubleshooting](#)

[Preparations](#)

[Parts and Controls](#)

[Basic Operations](#)[Connections](#)

[Other Operations](#)

[Apps](#)

[Announcements](#)

Data transfer

[Connecting a USB Compatible Device](#)[Connecting to a Computer](#)[Importing Content from Your Computer](#)[Pairing with a Bluetooth Device](#)[Turning On/Off the Bluetooth Function](#)

You might be looking for the following topics:

[Checking the Free Space](#)[Importing/Exporting Contents from an SD Memory Card](#)[Inserting/Removing an SD Memory Card](#)[Playing Photos/Videos](#)[Sharing Photos/Videos](#)[Supported Formats](#)[Using "Media Go"](#)

[▶ Troubleshooting](#)

[Preparations](#)

[Parts and Controls](#)

[Basic Operations](#)[Connections](#)

[Other Operations](#)

[Apps](#)

[Announcements](#)

Internet

[Connecting to Wi-Fi](#)[Enabling Mobile Communications \(SGPT13\)](#)[Setting Up an Access Point \(SGPT13\)](#)[Turning On/Off the Wi-Fi Function](#)

You might be looking for the following topics:

[Accessing Sites from Bookmarks/Access History](#)[Adding Bookmarks](#)[Browsing Websites](#)

[▶ Troubleshooting](#)

[Preparations](#)

[Parts and Controls](#)

[Basic Operations](#)

[Connections](#)

[Other Operations](#)

[Apps](#)

[Announcements](#)

Settings

[Connecting by Pressing the WPS Button on the Wi-Fi Router](#)[Connecting from the Wi-Fi Network List](#)[Connecting to Wi-Fi](#)[Pairing with a Bluetooth Device](#)[Turning On/Off the Bluetooth Function](#)[Turning On/Off the Wi-Fi Function](#)

You might be looking for the following topics:

[Changing the Settings](#)[Checking the Android Version](#)[Checking the Free Space](#)[Configuring Screen Rotation](#)[How to Maintain Battery Life](#)[Setting the Time that Elapses Before the Screen Turns Off \(Goes to Sleep\)](#)[Synchronizing the Account](#)[Updating Android to the Latest Version](#)[Using Location Services](#)



[▶ Troubleshooting](#)

Preparations

Parts and Controls

Basic Operations

Connections

Other Operations

Apps

Announcements

USB

[Connecting a USB Compatible Device](#)

[▶ Troubleshooting](#)

[Preparations](#)

[Parts and Controls](#)

[Basic Operations](#)[Connections](#)

[Other Operations](#)

[Apps](#)

[Announcements](#)

Wi-Fi

[Checking the Wi-Fi Connection](#)[Connecting by Pressing the WPS Button on the Wi-Fi Router](#)[Connecting from the Wi-Fi Network List](#)[Connecting to Wi-Fi](#)[Turning On/Off the Wi-Fi Function](#)

You might be looking for the following topics:

[Notes on Holding Your Tablet Device](#)[Notes on Using the Wi-Fi Function](#)[Specifications](#)[Using Location Services](#)



▶ [Troubleshooting](#)

Preparations

Parts and Controls

Basic Operations

Connections

Other Operations

Apps

Announcements

Computer

[Connecting to a Computer](#)

[Importing Content from Your Computer](#)

You might be looking for the following topics:

[Backing Up Data on Your Tablet Device](#)



▶ Troubleshooting

Preparations

Parts and Controls

Basic Operations

Connections

Other Operations

Apps

Announcements

HDMI

[Connecting to an HDMI Compatible Device](#)

[▶ Troubleshooting](#)

Preparations

Parts and Controls

Basic Operations

Connections

Other Operations

Apps

Announcements

Main unit

[Parts and Controls](#)

You might be looking for the following topics:

[Notes on Use](#)

[Splash-proof Performance](#)

[▶ Troubleshooting](#)

Preparations

Parts and Controls

Basic Operations

Connections

Other Operations

Apps

Announcements

Television

[Connecting to an HDMI Compatible Device](#)



▶ [Troubleshooting](#)

Preparations

Parts and Controls

Basic Operations

Connections

Other Operations

Apps

Announcements

WPS

[Connecting by Pressing the WPS Button on the Wi-Fi Router](#)

[▶ Troubleshooting](#)

[Preparations](#)

[Parts and Controls](#)

[Basic Operations](#)[Connections](#)[Other Operations](#)

[Apps](#)

[Announcements](#)

Wireless WAN

[Disabling Mobile Communications \(SGPT13\)](#)[Enabling Mobile Communications \(SGPT13\)](#)[Inserting/Removing a SIM Card \(SGPT13\)](#)[Setting Up an Access Point \(SGPT13\)](#)

You might be looking for the following topics:

[Notes on the SIM Card \(SGPT13\)](#)

[▶ Troubleshooting](#)

[Preparations](#)

[Parts and Controls](#)

[Basic Operations](#)

[Connections](#)

[Other Operations](#)

[Apps](#)

[Announcements](#)

Account

[Reverting to Factory Default \(Initializing Data\)](#)[Synchronizing the Account](#)

You might be looking for the following topics:

[Configuring a Google Account](#)[Configuring an E-mail Account](#)

[▶ Troubleshooting](#)

[Preparations](#)

[Parts and Controls](#)

[Basic Operations](#)

[Connections](#)

[Other Operations](#)

[Apps](#)

[Announcements](#)

Battery

[Adjusting the Screen Brightness](#)[Changing the Settings](#)[How to Maintain Battery Life](#)[Setting the Time that Elapses Before the Screen Turns Off \(Goes to Sleep\)](#)

You might be looking for the following topics:

[Charging the Battery](#)[Notes on Charging](#)[Notes on Using the AC Adapter](#)[Specifications](#)

[▶ Troubleshooting](#)

[Preparations](#)

[Parts and Controls](#)

[Basic Operations](#)

[Connections](#)

[Other Operations](#)

[Apps](#)

[Announcements](#)

Bluetooth

[Pairing with a Bluetooth Device](#)[Turning On/Off the Bluetooth Function](#)

You might be looking for the following topics:

[Notes on Holding Your Tablet Device](#)[Notes on Using the Bluetooth Function](#)

[▶ Troubleshooting](#)

[Preparations](#)

[Parts and Controls](#)

[Basic Operations](#)

[Connections](#)

[Other Operations](#)

[Apps](#)

[Announcements](#)

Browser

Using “Small Apps”

You might be looking for the following topics:

[Accessing Sites from Bookmarks/Access History](#)[Adding Bookmarks](#)[Browsing Websites](#)



▶ [Troubleshooting](#)

Preparations

Parts and Controls

Basic Operations

Connections

Other Operations

Apps

Announcements

Calendar

[Using the Calendar](#)



▶ [Troubleshooting](#)

Preparations

Parts and Controls

Basic Operations

Connections

Other Operations

Apps

Announcements

Computer

[Backing Up Data on Your Tablet Device](#)

[Connecting to a Computer](#)

[Importing Content from Your Computer](#)

[▶ Troubleshooting](#)

[Preparations](#)

[Parts and Controls](#)

[Basic Operations](#)

[Connections](#)

[Other Operations](#)

[Apps](#)

[Announcements](#)

Data transfer

[Checking the Free Space](#)[Connecting a USB Compatible Device](#)[Connecting to a Computer](#)[Importing Content from Your Computer](#)[Importing/Exporting Contents from an SD Memory Card](#)[Inserting/Removing an SD Memory Card](#)[Pairing with a Bluetooth Device](#)[Playing Photos/Videos](#)[Sharing Photos/Videos](#)[Supported Formats](#)[Turning On/Off the Bluetooth Function](#)

You might be looking for the following topics:

[Using "Media Go"](#)



[▶ Troubleshooting](#)

Preparations

Parts and Controls

Basic Operations

Connections

Other Operations

Apps

Announcements

Dock Speaker

[Using the “App Selector” with the tablet device attached to the Dock Speaker](#)

[▶ Troubleshooting](#)

[Preparations](#)

[Parts and Controls](#)

[Basic Operations](#)

[Connections](#)

[Other Operations](#)

[Apps](#)

[Announcements](#)

E-mail

Using “Gmail”

You might be looking for the following topics:

[Composing/Sending an E-mail](#)[Configuring an E-mail Account](#)[Receiving/Deleting E-mails](#)



▶ [Troubleshooting](#)

Preparations

Parts and Controls

Basic Operations

Connections

Other Operations

Apps

Announcements

HDMI

[Connecting to an HDMI Compatible Device](#)



[▶ Troubleshooting](#)

Preparations

Parts and Controls

Basic Operations

Connections

Other Operations

Apps

Announcements

Initialization

[Reverting to Factory Default \(Initializing Data\)](#)



[▶ Troubleshooting](#)

Preparations

Parts and Controls

Basic Operations

Connections

Other Operations

Apps

Announcements

Memory space

[Checking the Free Space](#)

[▶ Troubleshooting](#)

[Preparations](#)

[Parts and Controls](#)

[Basic Operations](#)

[Connections](#)

[Other Operations](#)

[Apps](#)

[Announcements](#)

Music

[Setting the Audio Output Sound](#)[Supported Formats](#)[Using the “App Selector” with the tablet device attached to the Dock Speaker](#)

You might be looking for the following topics:

[Using the “Music Unlimited” Music Delivery Service](#)[Using “Media Go”](#)[WALKMAN](#)

[▶ Troubleshooting](#)

Preparations

Parts and Controls

Basic Operations

Connections

Other Operations

Apps

Announcements

Power

[Resetting Your Tablet Device](#)

You might be looking for the following topics:

[Charging the Battery](#)

[Turning On or Shutting Down Your Tablet Device](#)

[Turning the Screen On/Off \(Sleep Mode\)](#)

[▶ Troubleshooting](#)

[Preparations](#)

[Parts and Controls](#)

[Basic Operations](#)

[Connections](#)

[Other Operations](#)

[Apps](#)

[Announcements](#)

Remote control

[Programming Operations in the Remote Control \(Macro Function\)](#)[Registering the Remote Control](#)[Using Your Tablet Device as a Remote Control](#)[Using “Small Apps”](#)

You might be looking for the following topics:

[Using “MediaRemote”](#)

[▶ Troubleshooting](#)

[Preparations](#)

[Parts and Controls](#)

[Basic Operations](#)

[Connections](#)

[Other Operations](#)

[Apps](#)

[Announcements](#)

SD Memory card

[Compatibility of SD Memory Cards](#)[Importing/Exporting Contents from an SD Memory Card](#)[Inserting/Removing an SD Memory Card](#)

You might be looking for the following topics:

[Notes on SD Memory Cards](#)[Notes on Use](#)[Splash-proof Performance](#)



▶ [Troubleshooting](#)

Preparations

Parts and Controls

Basic Operations

Connections

Other Operations

Apps

Announcements

Security

[Changing the Settings](#)

[Configuring to Lock the Screen](#)



▶ [Troubleshooting](#)

Preparations

Parts and Controls

Basic Operations

Connections

Other Operations

Apps

Announcements

Synching

[Synchronizing the Account](#)



▶ [Troubleshooting](#)

Preparations

Parts and Controls

Basic Operations

Connections

Other Operations

Apps

Announcements

USB

[Connecting a USB Compatible Device](#)

[▶ Troubleshooting](#)

[Preparations](#)

[Parts and Controls](#)

[Basic Operations](#)

[Connections](#)

[Other Operations](#)

[Apps](#)

[Announcements](#)

Wi-Fi

Using Location Services

You might be looking for the following topics:

[Checking the Wi-Fi Connection](#)[Connecting by Pressing the WPS Button on the Wi-Fi Router](#)[Connecting from the Wi-Fi Network List](#)[Connecting to Wi-Fi](#)[Notes on Holding Your Tablet Device](#)[Notes on Using the Wi-Fi Function](#)[Specifications](#)[Turning On/Off the Wi-Fi Function](#)



▶ [Troubleshooting](#)

Preparations

Parts and Controls

Basic Operations

Connections

Other Operations

Apps

Announcements

Backup

[Backing Up Data on Your Tablet Device](#)

[▶ Troubleshooting](#)

[Preparations](#)

[Parts and Controls](#)

[Basic Operations](#)

[Connections](#)

[Other Operations](#)

[Apps](#)

[Announcements](#)

Battery charge

[How to Maintain Battery Life](#)

You might be looking for the following topics:

[Charging the Battery](#)[Notes on Using the AC Adapter](#)



▶ [Troubleshooting](#)

Preparations

Parts and Controls

Basic Operations

Connections

Other Operations

Apps

Announcements

Books

[Reading Digital Books](#)



[▶ Troubleshooting](#)

Preparations

Parts and Controls

Basic Operations

Connections

Other Operations

Apps

Announcements

Calculator

[Using the Calculator](#)

[Using “Small Apps”](#)



▶ [Troubleshooting](#)

Preparations

Parts and Controls

Basic Operations

Connections

Other Operations

Apps

Announcements

Clock

[Displaying the Clock](#)



▶ [Troubleshooting](#)

Preparations

Parts and Controls

Basic Operations

Connections

Other Operations

Apps

Announcements

Contacts

[Grouping/Joining Contacts](#)

[Registering Contacts](#)

[▶ Troubleshooting](#)

[Preparations](#)

[Parts and Controls](#)

[Basic Operations](#)

[Connections](#)

[Other Operations](#)

[Apps](#)

[Announcements](#)

Display

[Adjusting the Screen Brightness](#)[Changing the Settings](#)[Configuring to Lock the Screen](#)[Setting the Time that Elapses Before the Screen Turns Off \(Goes to Sleep\)](#)[Sharing the Tablet Device with Family or Friends \(Guest Mode\)](#)[Switching to Guest Mode](#)

You might be looking for the following topics:

[Adding Apps or Widgets to the Home Screen](#)[Configuring Screen Rotation](#)[Notes on the Screen](#)[Touch Screen Operations](#)[Turning the Screen On/Off \(Sleep Mode\)](#)[Using the Home Screen](#)



▶ [Troubleshooting](#)

Preparations

Parts and Controls

Basic Operations

Connections

Other Operations

Apps

Announcements

Download

[Downloading the Help guide](#)

You might be looking for the following topics:

[Confirming Download or Update Information on the Status Bar](#)



▶ [Troubleshooting](#)

Preparations

Parts and Controls

Basic Operations

Connections

Other Operations

Apps

Announcements

GPS

[Using Location Services](#)

You might be looking for the following topics:

[Notes on GPS Function](#)

[Notes on Holding Your Tablet Device](#)

[▶ Troubleshooting](#)

[Preparations](#)

[Parts and Controls](#)

[Basic Operations](#)

[Connections](#)

[Other Operations](#)

[Apps](#)

[Announcements](#)

Home

[Sharing the Tablet Device with Family or Friends \(Guest Mode\)](#)[Switching to Guest Mode](#)[Using “Small Apps”](#)

You might be looking for the following topics:

[Adding Apps or Widgets to the Home Screen](#)[Confirming Download or Update Information on the Status Bar](#)[Searching with Google](#)[Touch Screen Operations](#)[Using the Apps & Widgets List](#)[Using the Home Screen](#)



▶ [Troubleshooting](#)

Preparations

Parts and Controls

Basic Operations

Connections

Other Operations

Apps

Announcements

Lock

[Configuring to Lock the Screen](#)

[▶ Troubleshooting](#)

[Preparations](#)

[Parts and Controls](#)

[Basic Operations](#)

[Connections](#)

[Other Operations](#)

[Apps](#)

[Announcements](#)

Movies

[Playing Photos/Videos](#)[Setting the Audio Output Sound](#)[Sharing Photos/Videos](#)[Shooting Photos/Movies](#)

You might be looking for the following topics:

[Album](#)[Movies](#)[Notes on Recorded Photos/Movies](#)



▶ [Troubleshooting](#)

Preparations

Parts and Controls

Basic Operations

Connections

Other Operations

Apps

Announcements

Photos

[Editing Photos](#)

[Playing Photos/Videos](#)

[Sharing Photos/Videos](#)

[Shooting Photos/Movies](#)

[Supported Formats](#)

You might be looking for the following topics:

[Album](#)

[Notes on Recorded Photos/Movies](#)

[Using "Media Go"](#)



▶ [Troubleshooting](#)

Preparations

Parts and Controls

Basic Operations

Connections

Other Operations

Apps

Announcements

Registration

[Registering Your Tablet Device](#)

[Registration](#)



▶ [Troubleshooting](#)

Preparations

Parts and Controls

Basic Operations

Connections

Other Operations

Apps

Announcements

Reset

[Resetting Your Tablet Device](#)

[Reverting to Factory Default \(Initializing Data\)](#)



▶ [Troubleshooting](#)

Preparations

Parts and Controls

Basic Operations

Connections

Other Operations

Apps

Announcements

Search

[Using Sony Select](#)

You might be looking for the following topics:

[Searching for Apps](#)

[Searching with Google](#)

[▶ Troubleshooting](#)

[Preparations](#)

[Parts and Controls](#)

[Basic Operations](#)

[Connections](#)

[Other Operations](#)

[Apps](#)

[Announcements](#)

Settings

[Changing the Settings](#)[Checking the Android Version](#)[Checking the Free Space](#)[How to Maintain Battery Life](#)[Pairing with a Bluetooth Device](#)[Setting the Time that Elapses Before the Screen Turns Off \(Goes to Sleep\)](#)[Synchronizing the Account](#)[Turning On/Off the Bluetooth Function](#)[Updating Android to the Latest Version](#)[Using Location Services](#)

You might be looking for the following topics:

[Configuring Screen Rotation](#)[Connecting by Pressing the WPS Button on the Wi-Fi Router](#)[Connecting from the Wi-Fi Network List](#)[Connecting to Wi-Fi](#)[Turning On/Off the Wi-Fi Function](#)



▶ [Troubleshooting](#)

Preparations

Parts and Controls

Basic Operations

Connections

Other Operations

Apps

Announcements

Television

[Connecting to an HDMI Compatible Device](#)



▶ [Troubleshooting](#)

Preparations

Parts and Controls

Basic Operations

Connections

Other Operations

Apps

Announcements

Version

[Checking the Android Version](#)

[Updating Android to the Latest Version](#)

[▶ Troubleshooting](#)

[Preparations](#)

[Parts and Controls](#)

[Basic Operations](#)

[Connections](#)

[Other Operations](#)

[Apps](#)

[Announcements](#)

Account

[Configuring an E-mail Account](#)

You might be looking for the following topics:

[Configuring a Google Account](#)[Reverting to Factory Default \(Initializing Data\)](#)[Synchronizing the Account](#)

[▶ Troubleshooting](#)

[Preparations](#)

[Parts and Controls](#)

[Basic Operations](#)

[Connections](#)

[Other Operations](#)[Apps](#)[Announcements](#)

Browser

[Accessing Sites from Bookmarks/Access History](#)[Adding Bookmarks](#)[Browsing Websites](#)

You might be looking for the following topics:

[Using “Small Apps”](#)



[▶ Troubleshooting](#)

Preparations

Parts and Controls

Basic Operations

Connections

Other Operations

Apps

Announcements

Calendar

[Using the Calendar](#)



▶ [Troubleshooting](#)

Preparations

Parts and Controls

Basic Operations

Connections

Other Operations

Apps

Announcements

Clock

[Displaying the Clock](#)

[▶ Troubleshooting](#)

[Preparations](#)

[Parts and Controls](#)

[Basic Operations](#)

[Connections](#)

[Other Operations](#)

[Apps](#)

[Announcements](#)

Data transfer

[Playing Photos/Videos](#)[Sharing Photos/Videos](#)[Using “Media Go”](#)

You might be looking for the following topics:

[Checking the Free Space](#)[Connecting a USB Compatible Device](#)[Connecting to a Computer](#)[Importing Content from Your Computer](#)[Importing/Exporting Contents from an SD Memory Card](#)[Inserting/Removing an SD Memory Card](#)[Pairing with a Bluetooth Device](#)[Supported Formats](#)[Turning On/Off the Bluetooth Function](#)



▶ [Troubleshooting](#)

Preparations

Parts and Controls

Basic Operations

Connections

Other Operations

Apps

Announcements

Facebook

[Socialife](#)

[▶ Troubleshooting](#)

[Preparations](#)

[Parts and Controls](#)

[Basic Operations](#)

[Connections](#)

[Other Operations](#)

[Apps](#)

[Announcements](#)

Internet

[Accessing Sites from Bookmarks/Access History](#)[Adding Bookmarks](#)[Browsing Websites](#)

You might be looking for the following topics:

[Connecting to Wi-Fi](#)[Enabling Mobile Communications \(SGPT13\)](#)[Setting Up an Access Point \(SGPT13\)](#)[Turning On/Off the Wi-Fi Function](#)



[▶ Troubleshooting](#)

Preparations

Parts and Controls

Basic Operations

Connections

Other Operations

Apps

Announcements

Memo

[Scrapbook](#)

[▶ Troubleshooting](#)

[Preparations](#)

[Parts and Controls](#)

[Basic Operations](#)

[Connections](#)

[Other Operations](#)[Apps](#)[Announcements](#)

Music

[Setting the Audio Output Sound](#)[Using the “Music Unlimited” Music Delivery Service](#)[Using “Media Go”](#)[WALKMAN](#)

You might be looking for the following topics:

[Supported Formats](#)[Using the “App Selector” with the tablet device attached to the Dock Speaker](#)

[▶ Troubleshooting](#)

Preparations

Parts and Controls

Basic Operations

Connections

Other Operations

Apps

Announcements

Registration

[Registering Your Tablet Device](#)

[Registration](#)



▶ [Troubleshooting](#)

Preparations

Parts and Controls

Basic Operations

Connections

Other Operations

Apps

Announcements

SNS

[Socialife](#)



▶ [Troubleshooting](#)

Preparations

Parts and Controls

Basic Operations

Connections

Other Operations

Apps

Announcements

Search

[Searching for Apps](#)

[Using Sony Select](#)

You might be looking for the following topics:

[Searching with Google](#)



▶ [Troubleshooting](#)

Preparations

Parts and Controls

Basic Operations

Connections

Other Operations

Apps

Announcements

Videos

[Using the "Video Unlimited" Video Delivery Service](#)



[▶ Troubleshooting](#)

Preparations

Parts and Controls

Basic Operations

Connections

Other Operations

Apps

Announcements

Books

[Reading Digital Books](#)



▶ [Troubleshooting](#)

Preparations

Parts and Controls

Basic Operations

Connections

Other Operations

Apps

Announcements

Calculator

[Using the Calculator](#)

You might be looking for the following topics:

[Using "Small Apps"](#)



[▶ Troubleshooting](#)

Preparations

Parts and Controls

Basic Operations

Connections

Other Operations

Apps

Announcements

Clip

[Scrapbook](#)



▶ [Troubleshooting](#)

Preparations

Parts and Controls

Basic Operations

Connections

Other Operations

Apps

Announcements

Contacts

[Grouping/Joining Contacts](#)

[Registering Contacts](#)

▶ [Troubleshooting](#)

Preparations

Parts and Controls

Basic Operations

Connections

Other Operations

Apps

Announcements

E-mail

[Composing/Sending an E-mail](#)

[Configuring an E-mail Account](#)

[Receiving/Deleting E-mails](#)

[Using "Gmail"](#)



▶ [Troubleshooting](#)

Preparations

Parts and Controls

Basic Operations

Connections

Other Operations

Apps

Announcements

Games

[PSM](#)



[▶ Troubleshooting](#)

Preparations

Parts and Controls

Basic Operations

Connections

Other Operations

Apps

Announcements

List of apps

[List of Apps](#)

[▶ Troubleshooting](#)

[Preparations](#)

[Parts and Controls](#)

[Basic Operations](#)

[Connections](#)

[Other Operations](#)

[Apps](#)

[Announcements](#)

Movies

[Album](#)[Movies](#)[Playing Photos/Videos](#)[Setting the Audio Output Sound](#)[Sharing Photos/Videos](#)[Shooting Photos/Movies](#)

You might be looking for the following topics:

[Notes on Recorded Photos/Movies](#)

[▶ Troubleshooting](#)

[Preparations](#)

[Parts and Controls](#)

[Basic Operations](#)

[Connections](#)

[Other Operations](#)

[Apps](#)

[Announcements](#)

Photos

[Album](#)[Editing Photos](#)[Playing Photos/Videos](#)[Sharing Photos/Videos](#)[Shooting Photos/Movies](#)[Using "Media Go"](#)

You might be looking for the following topics:

[Notes on Recorded Photos/Movies](#)[Supported Formats](#)

[▶ Troubleshooting](#)

[Preparations](#)

[Parts and Controls](#)

[Basic Operations](#)

[Connections](#)

[Other Operations](#)

[Apps](#)

[Announcements](#)

Remote control

[Programming Operations in the Remote Control \(Macro Function\)](#)[Registering the Remote Control](#)[Using Your Tablet Device as a Remote Control](#)[Using “MediaRemote”](#)

You might be looking for the following topics:

[Using “Small Apps”](#)



[▶ Troubleshooting](#)

Preparations

Parts and Controls

Basic Operations

Connections

Other Operations

Apps

Announcements

Scrapbook

[Scrapbook](#)



▶ [Troubleshooting](#)

Preparations

Parts and Controls

Basic Operations

Connections

Other Operations

Apps

Announcements

Twitter

[Socialife](#)

[▶ Troubleshooting](#)

[Preparations](#)

[Parts and Controls](#)

[Basic Operations](#)

[Connections](#)

[Other Operations](#)

[Apps](#)

[Announcements](#)

Account

[Reverting to Factory Default \(Initializing Data\)](#)

You might be looking for the following topics:

[Configuring a Google Account](#)[Configuring an E-mail Account](#)[Synchronizing the Account](#)

[▶ Troubleshooting](#)

[Preparations](#)

[Parts and Controls](#)

[Basic Operations](#)

[Connections](#)

[Other Operations](#)

[Apps](#)

[Announcements](#)

Battery charge

[Notes on Using the AC Adapter](#)

You might be looking for the following topics:

[Charging the Battery](#)[How to Maintain Battery Life](#)



▶ [Troubleshooting](#)

Preparations

Parts and Controls

Basic Operations

Connections

Other Operations

Apps

Announcements

Chat

[Notes on Using Voice Communications Apps \(SGPT13\)](#)

[▶ Troubleshooting](#)

[Preparations](#)

[Parts and Controls](#)

[Basic Operations](#)

[Connections](#)

[Other Operations](#)

[Apps](#)

[Announcements](#)

GPS

[Notes on GPS Function](#)[Notes on Holding Your Tablet Device](#)

You might be looking for the following topics:

[Using Location Services](#)



[▶ Troubleshooting](#)

Preparations

Parts and Controls

Basic Operations

Connections

Other Operations

Apps

Announcements

Internet telephone

[Notes on Using Voice Communications Apps \(SGPT13\)](#)

[▶ Troubleshooting](#)

[Preparations](#)

[Parts and Controls](#)

[Basic Operations](#)

[Connections](#)

[Other Operations](#)

[Apps](#)

[Announcements](#)

Movies

[Notes on Recorded Photos/Movies](#)

You might be looking for the following topics:

[Album](#)[Movies](#)[Playing Photos/Videos](#)[Setting the Audio Output Sound](#)[Sharing Photos/Videos](#)[Shooting Photos/Movies](#)

[▶ Troubleshooting](#)

[Preparations](#)

[Parts and Controls](#)

[Basic Operations](#)

[Connections](#)

[Other Operations](#)

[Apps](#)

[Announcements](#)

Power

[Resetting Your Tablet Device](#)

You might be looking for the following topics:

[Charging the Battery](#)[Turning On or Shutting Down Your Tablet Device](#)[Turning the Screen On/Off \(Sleep Mode\)](#)



▶ [Troubleshooting](#)

Preparations

Parts and Controls

Basic Operations

Connections

Other Operations

Apps

Announcements

Reset

[Resetting Your Tablet Device](#)

[Reverting to Factory Default \(Initializing Data\)](#)

[▶ Troubleshooting](#)

[Preparations](#)

[Parts and Controls](#)

[Basic Operations](#)

[Connections](#)

[Other Operations](#)

[Apps](#)

[Announcements](#)

Settings

[Checking the Android Version](#)[Updating Android to the Latest Version](#)

You might be looking for the following topics:

[Changing the Settings](#)[Checking the Free Space](#)[Configuring Screen Rotation](#)[Connecting by Pressing the WPS Button on the Wi-Fi Router](#)[Connecting from the Wi-Fi Network List](#)[Connecting to Wi-Fi](#)[How to Maintain Battery Life](#)[Pairing with a Bluetooth Device](#)[Setting the Time that Elapses Before the Screen Turns Off \(Goes to Sleep\)](#)[Synchronizing the Account](#)[Turning On/Off the Bluetooth Function](#)[Turning On/Off the Wi-Fi Function](#)[Using Location Services](#)



[▶ Troubleshooting](#)

Preparations

Parts and Controls

Basic Operations

Connections

Other Operations

Apps

Announcements

Trademarks

[Trademarks](#)

[▶ Troubleshooting](#)

[Preparations](#)

[Parts and Controls](#)

[Basic Operations](#)

[Connections](#)

[Other Operations](#)

[Apps](#)

[Announcements](#)

Wi-Fi

[Notes on Holding Your Tablet Device](#)[Notes on Using the Wi-Fi Function](#)[Specifications](#)

You might be looking for the following topics:

[Checking the Wi-Fi Connection](#)[Connecting by Pressing the WPS Button on the Wi-Fi Router](#)[Connecting from the Wi-Fi Network List](#)[Connecting to Wi-Fi](#)[Turning On/Off the Wi-Fi Function](#)[Using Location Services](#)

[▶ Troubleshooting](#)

[Preparations](#)

[Parts and Controls](#)

[Basic Operations](#)

[Connections](#)

[Other Operations](#)

[Apps](#)[Announcements](#)

Battery

[Notes on Charging](#)[Notes on Using the AC Adapter](#)[Specifications](#)

You might be looking for the following topics:

[Adjusting the Screen Brightness](#)[Changing the Settings](#)[Charging the Battery](#)[How to Maintain Battery Life](#)[Setting the Time that Elapses Before the Screen Turns Off \(Goes to Sleep\)](#)

[▶ Troubleshooting](#)

[Preparations](#)

[Parts and Controls](#)

[Basic Operations](#)

[Connections](#)

[Other Operations](#)

[Apps](#)

[Announcements](#)

Bluetooth

[Notes on Holding Your Tablet Device](#)[Notes on Using the Bluetooth Function](#)

You might be looking for the following topics:

[Pairing with a Bluetooth Device](#)[Turning On/Off the Bluetooth Function](#)

[▶ Troubleshooting](#)

[Preparations](#)

[Parts and Controls](#)

[Basic Operations](#)

[Connections](#)

[Other Operations](#)

[Apps](#)

[Announcements](#)

Display

[Notes on the Screen](#)

You might be looking for the following topics:

[Adding Apps or Widgets to the Home Screen](#)[Adjusting the Screen Brightness](#)[Changing the Settings](#)[Configuring Screen Rotation](#)[Configuring to Lock the Screen](#)[Setting the Time that Elapses Before the Screen Turns Off \(Goes to Sleep\)](#)[Sharing the Tablet Device with Family or Friends \(Guest Mode\)](#)[Switching to Guest Mode](#)[Touch Screen Operations](#)[Turning the Screen On/Off \(Sleep Mode\)](#)[Using the Home Screen](#)



[▶ Troubleshooting](#)

Preparations

Parts and Controls

Basic Operations

Connections

Other Operations

Apps

Announcements

Initialization

[Reverting to Factory Default \(Initializing Data\)](#)

[▶ Troubleshooting](#)

[Preparations](#)

[Parts and Controls](#)

[Basic Operations](#)

[Connections](#)

[Other Operations](#)

[Apps](#)

[Announcements](#)

Main unit

[Notes on Use](#)[Splash-proof Performance](#)

You might be looking for the following topics:

[Parts and Controls](#)

[▶ Troubleshooting](#)

[Preparations](#)

[Parts and Controls](#)

[Basic Operations](#)

[Connections](#)

[Other Operations](#)

[Apps](#)

[Announcements](#)

Photos

[Notes on Recorded Photos/Movies](#)

You might be looking for the following topics:

[Album](#)[Editing Photos](#)[Playing Photos/Videos](#)[Sharing Photos/Videos](#)[Shooting Photos/Movies](#)[Supported Formats](#)[Using "Media Go"](#)



[▶ Troubleshooting](#)

Preparations

Parts and Controls

Basic Operations

Connections

Other Operations

Apps

Announcements

Read this first

[Read This First](#)

[▶ Troubleshooting](#)

[Preparations](#)

[Parts and Controls](#)

[Basic Operations](#)

[Connections](#)

[Other Operations](#)

[Apps](#)

[Announcements](#)

SD Memory card

[Compatibility of SD Memory Cards](#)[Notes on SD Memory Cards](#)[Notes on Use](#)[Splash-proof Performance](#)

You might be looking for the following topics:

[Importing/Exporting Contents from an SD Memory Card](#)[Inserting/Removing an SD Memory Card](#)



[▶ Troubleshooting](#)

Preparations

Parts and Controls

Basic Operations

Connections

Other Operations

Apps

Announcements

Specifications

[Specifications](#)



▶ [Troubleshooting](#)

Preparations

Parts and Controls

Basic Operations

Connections

Other Operations

Apps

Announcements

Version

[Checking the Android Version](#)

[Updating Android to the Latest Version](#)

[▶ Troubleshooting](#)

[Preparations](#)

[Parts and Controls](#)

[Basic Operations](#)

[Connections](#)

[Other Operations](#)

[Apps](#)

[Announcements](#)

Wireless WAN

[Notes on the SIM Card \(SGPT13\)](#)

You might be looking for the following topics:

[Disabling Mobile Communications \(SGPT13\)](#)[Enabling Mobile Communications \(SGPT13\)](#)[Inserting/Removing a SIM Card \(SGPT13\)](#)[Setting Up an Access Point \(SGPT13\)](#)



▶ [How to Use](#)

Network / Internet

Tablet Device

Apps

Network / Internet

[GPS](#)

[Wi-Fi](#)



[▶ How to Use](#)

[Network / Internet](#)

[Tablet Device](#)

[Apps](#)

Tablet Device

[Battery](#)

[Display](#)

[Power](#)

[Sound](#)

[Bluetooth](#)

[Main unit](#)

[Settings](#)



▶ [How to Use](#)

[Network / Internet](#)

[Tablet Device](#)

[Apps](#)

Apps

[Browser](#)

[File](#)

[Images](#)

[Settings](#)

[Camera](#)

[GPS](#)

[Remote control](#)

[Sound](#)

[▶ Troubleshooting](#)

[Preparations](#)

[Parts and Controls](#)

[Basic Operations](#)

[Connections](#)



[Other Operations](#)

[Apps](#)

[Announcements](#)

Searching for Apps

Apps such as helpful tools and games can be downloaded to your tablet device from Google Play provided by Google. You can also check for app updates and update apps to the latest version.

Tap [ Apps & Widgets] at the top right of the Home screen, followed by [ Play Store] on the apps list.

You can also use Google Play from your computer.

<http://play.google.com/>

This site displays Google Play and allows you to manage apps you downloaded from Google Play and installed on your tablet device.

To use Play Store, you need to sign-in your Google account [[Details](#)].

▶ [Troubleshooting](#)

Preparations

Parts and Controls

Basic Operations

Connections

Other Operations

Apps

Announcements

Confirming Download or Update Information on the Status Bar

The notification icons tell you that downloading is complete, you have e-mails, or updates are available. By tapping the status bar, you can display the notification panel. You can display the control panel and open downloaded files directly from the notification panel.

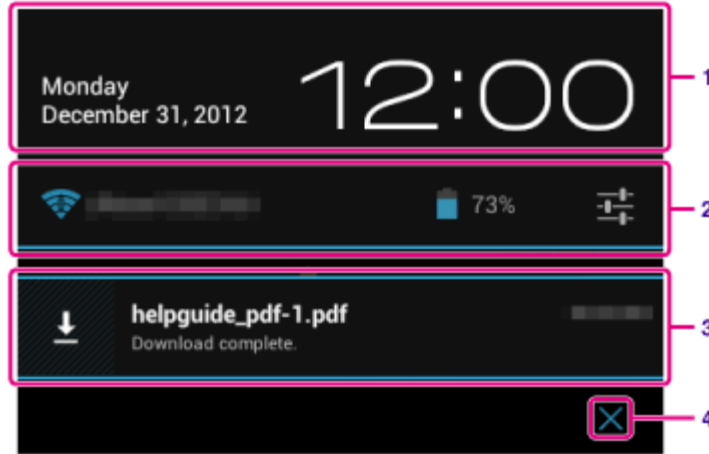

	Description
1	Tap to display the control panel.
2	Displays the status of the battery and Wi-Fi connection.
3	Tap to open items you are notified about and related apps directly.
4	Closes the notification panel.

Note

- If you close the notification panel, the notification will be deleted. You can display the downloaded content from the [ Downloads] app.

You can control the following items from the control panel.

- Airplane mode: Turns on/off airplane mode. When this mode is turned on, wireless communications are turned off.
- Wi-Fi: Displays the Wi-Fi setting screen [[Details](#)].
- Auto-rotate screen: Locks the screen so it does not rotate automatically [[Details](#)].
- Brightness: Adjusts the screen brightness [[Details](#)].
- Notifications: Turns on/off notifications. If you turn this off, the notification icons will not appear on the status bar.
- Settings: Displays the settings screen.

Related Topic

[Changing the Settings](#)

▶ [Troubleshooting](#)[Preparations](#)[Parts and Controls](#)[Basic Operations](#)[Connections](#)[Other Operations](#)[Apps](#)[Announcements](#)

Charging the Battery

The battery charges while your tablet device is plugged in. Charging time will vary depending on how you use your tablet device.

1. Plug the supplied USB cable for Multi Port into the AC adapter.
2. Plug an AC power cord (mains lead) into the AC adapter.

Note

- AC power cord (mains lead) is not supplied in some countries/regions.

3. Plug the AC adapter or an AC power cord (mains lead) to the AC outlet (wall socket).
4. Turn over your tablet device, and then remove the cover for the Multi Port.

Note

- The Multi Port cover is necessary to utilize the splash-proof feature. Keep the Multi Port cover in a safe place.

5. Plug the USB cable for Multi Port into the Multi Port of your tablet device in the direction shown below.

The charge indicator shows the battery charging status.

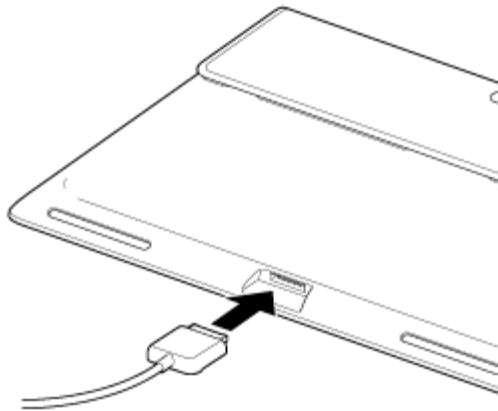
**Hint**

- Using the designated Sony cradle (SGPDS2, sold separately) for your tablet device allows you to charge the battery easier.

Checking the remaining battery level/charging status

You can check the remaining battery level with the icon displayed on the status bar on the Home screen.

The charge indicator tells you the charging status. The charge indicator lights up in different colors, depending on the remaining battery level.

Charging status	Remaining battery level	Display status
	Low (0 - 15 %)	Red

With the AC adapter	Mid (16 - 89 %)	Orange
	Full (90 - 100 %)	Green
Without the AC adapter	Low (0 - 15 %)	Red flashing
	Mid (16 - 89 %)	Off
	Full (90 - 100 %)	Off

Note

- The charge indicator flashes in red when the battery level becomes low and the tablet device requires charging to continue operation.

Related Topic

[Parts and Controls](#)

[Specifications](#)

[Confirming Download or Update Information on the Status Bar](#)

[Notes on Using the AC Adapter](#)

[Notes on Charging](#)

[▶ Troubleshooting](#)

[Preparations](#)

[Parts and Controls](#)

[Basic Operations](#)

[Connections](#)



[Other Operations](#)

[Apps](#)

[Announcements](#)

Synchronizing the Account

Synchronizing with the account enables you to check variety of information set on the tablet device online.

1. Tap [ Apps & Widgets] - [ Settings] - [Accounts & sync].
2. Set the switch at the top right of the screen to [ON].
3. Tap [ADD ACCOUNT], and then select the account you want to synchronize.
4. Tap the account you added, and then select the item you want to synchronize.
5. Tap , and then go back to the account list.

To delete an account

1. Tap the account you want to delete on the account list.
2. Tap  (Option menu) - [Remove account].

Note

- The account is removed from the tablet device, but the account itself is not deleted.

Related Topic

[Configuring a Google Account](#)

▶ Troubleshooting

Preparations

Parts and Controls

Basic Operations

Connections

Other Operations

Apps

Announcements

Configuring a Google Account

You must sign up for a Google account to use services provided by Google, such as Google Play Store (free registration).

With a Google account, you can sync apps such as Email, Calendar and People on your tablet device with other devices that also support Google services.

Use your current Google account

If you already have a Google account that you use with a computer or smartphone, you can use that account with your tablet device too. Input your account name and password in the login screen displayed for Google service apps.



Note

- Make sure that your tablet device is connected to the Internet when you sign up for a new Google account or log in.

Sign up for a new Google account on your tablet device

You can sign up for a Google account when you use your tablet device for the first time or start a Google service app for the first time.

Hint

- You do not have to sign up for another Google account if you already have one.
- You can sign up for a Google account by tapping [ Apps & Widgets] - [ Settings] - [Accounts & sync] - [Add account] (at the top right of the screen) - [Google] in that order.
- You can also sign up for a Google account by accessing Google (<https://www.google.com/accounts/>) directly.

Related Topic[Entering Text](#)[Synchronizing the Account](#)[Changing the Settings](#)

[▶ Troubleshooting](#)

[Preparations](#)

[Parts and Controls](#)

[Basic Operations](#)

[Connections](#)

[Other Operations](#)

[Apps](#)

[Announcements](#)



Searching with Google

You can search websites, apps downloaded to the tablet device or data using Google Search.

To search by text

1. Tap [Google] on the top left of the Home screen, and enter keywords.
2. Tap an item on the search result list.
By tapping  on the keyboard, you can start the Browser app and also display the search results.

To search by voice

1. On the top left of the Home screen tap , or [Google] and then tap .
2. Speak keywords by following the on-screen instructions.
The Browser app starts and displays the search results.

Related Topic

[Entering Text](#)

[▶ Troubleshooting](#)

[Preparations](#)

[Parts and Controls](#)

[Basic Operations](#)

[Connections](#)

[Other Operations](#)

[Apps](#)

[Announcements](#)

Sharing the Tablet Device with Family or Friends (Guest Mode)

If you share your tablet device with other users, registering Guest Mode enables you to make a Home screen for the guest. On the Home screen for the guest, only apps the guest is allowed to use are displayed, and you can set what wallpaper is displayed according to the mode.

To register a Guest Mode

1. Tap [ Guest Mode] on the Home screen.
2. Tap [Start].
3. Enter a name for the Guest Mode by following the on-screen instructions, and then tap [Next].
4. Select whether to restrict the use of apps, and then tap [Next].
 - If you select [Limited applications], tap apps you will allow the guest to use on the app selection screen, and then tap [SAVE] at the top right of the screen.
5. Select whether to set an unlock code, and then tap [Next].

To set an unlock code, select [Set code].

 - If you select [Set code], set a cancellation code by following the on-screen instructions.
6. Check the registration information for the Guest Mode, and then tap [Done].

Related Topic

[Using the Home Screen](#)[Switching to Guest Mode](#)

▶ Troubleshooting

Preparations

Parts and Controls

Basic Operations

Connections

Other Operations

Apps

Announcements

Using the Apps & Widgets List

When you tap [ Apps & Widgets] on the Home screen, the apps and widgets list is displayed.

The apps list displays the icons of all available apps. The widgets list displays widgets that you can place on the Home screen. If an app is supplied with a widget, place the widget on the Home screen so that you can operate the app from the Home screen easily.

Switching between the apps and widgets list

1. Tap [Apps] or [Widgets] at the top left of the screen.

Hint

- The apps and widgets list contains multiple pages. Flick left and right to move between pages. The apps list is displayed before the list of widgets.

Sorting apps and widgets

1. Tap [] at the top right of the screen and select a sorting method.
[A to Z] : Sort by name.
[Newest first] : Sort by date of update.

Uninstalling (Deleting) an application

1. Tap and hold the icon of the app you want to uninstall from the apps list.
2. While holding the icon, drag and drop it to [ Uninstall] displayed on the Home screen.

Note

- Some applications cannot be uninstalled (deleted). This does not indicate a malfunction of the tablet device or a bug in the application.

Displaying the app information

1. Tap and hold the icon of the app you want to check information of.
2. While holding the icon, drag and drop it to [ App info] displayed on the Home screen.

Hint

- If the Play Store app is installed, [] is displayed to the left of []. You can start the Play Store app by tapping [].

Related Topic

[Using the Home Screen](#)

[Adding Apps or Widgets to the Home Screen](#)

[List of Apps](#)

▶ Troubleshooting

Preparations

Parts and Controls

Basic Operations

Connections

Other Operations

Apps

Announcements

Using "Small Apps"

There are a number of apps installed on the tablet device called Small Apps. Small Apps give you the flexibility to open certain apps without closing other apps. For example, you may have an app such as the Email app open and want to open another app such as the Browser app. Instead of closing the Email app and opening the Browser app, you can keep the Email app open and start the Browser Small App. The Small App (Browser) is then displayed over the existing app (Email).

To start Small Apps

1. Tap  on the Home screen.
The Small Apps launcher appears.
2. Tap the app you want to start.

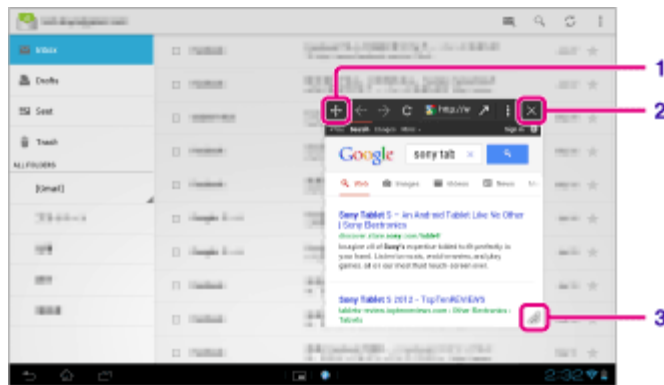

Display on the screen		Description
1	Move	Dragging this moves the Small Apps window. Double tap to resize the window to a size appropriate for the screen (Unavailable in some apps that cannot resize the window.).
2	Close	Closes Small Apps.
3	Expand/Contract the window	Drag to expand/contract the window (Unavailable in some apps that cannot resize the window.).

To set a shortcut

You can create shortcuts for Small Apps you often use.

1. On the Small Apps launcher, tap and hold the app you want to set.
The menu appears.
2. Tap [Create shortcut to this item].
A shortcut is created to the right of .

Hint

- By tapping  on the Small Apps launcher and then tapping [Clear shortcut], you can delete the shortcut you set.

To use a widget

You can display a widget while another app is in use.

To add a widget

1. Tap  Add] on the Small Apps launcher.
2. Tap the widget you want to add.
3. Enter a label name, and then tap [OK].
The widget is added to the Small Apps launcher.

To delete a widget

1. On the Small Apps launcher, tap and hold the widget you want to delete.
The menu appears.
2. Tap [Remove from screen].

Hint

- Only widgets can be deleted from the Small Apps launcher. Apps cannot be deleted from the launcher.

Related Topic

[Using the Home Screen](#)

[Registering the Remote Control](#)

[Using the Calculator](#)

[Browsing Websites](#)

▶ Troubleshooting

Using the Calendar

Preparations

Parts and Controls

Basic Operations

Connections

Other Operations

Apps

Announcements

You can manage your schedule on your tablet device. By registering your Google account, you can sync your Google Calendar and your schedule data.

1. Tap [⋮ Apps & Widgets] - [📅 Calendar].

The calendar is displayed.

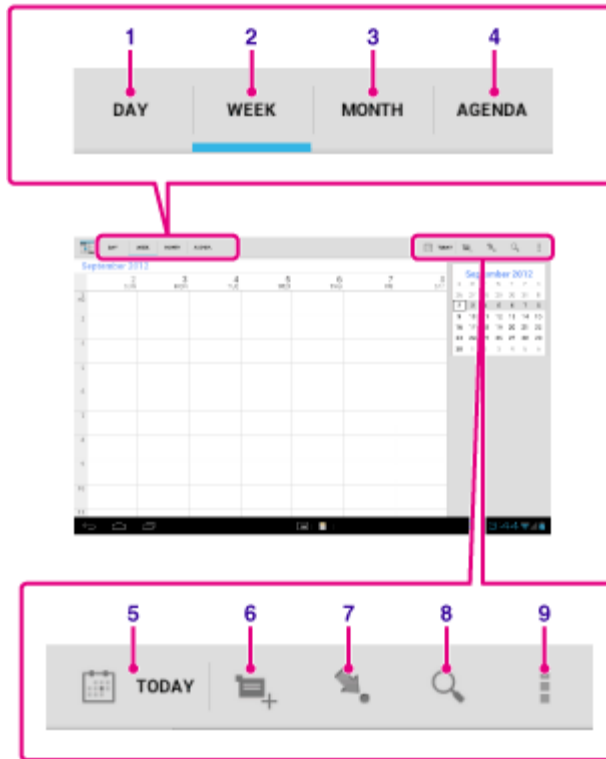



Display on the screen		Description
1	DAY	Displays the events for one day.
2	WEEK	Displays the calendar by week.
3	MONTH	Displays the calendar by month.
4	AGENDA	Displays the list of scheduled items.
5	TODAY	Displays today's schedule.
6	New event	Adds events.
7	Set date	Sets a date to be displayed.
8	Search	Searches for an event.
9	Option menu	Makes detailed settings such as refreshing the display or configuring general settings for Calendar.

Hint

- You can flick up/down/right/left on the schedule list or mini-calendar to browse through months or dates and times to find events.



Adding an event

1. Tap and hold the date and time you want to add an event for, and then tap [New event]. Or, tap .
2. Input the starting date and time and details of the schedule, and then tap [ DONE] at the top right of the screen.

Hint

- You can have your tablet device notify you when close to the scheduled date and time.

Changing an event

1. Tap the event you want to change.
2. Tap , input the item to be changed, and then tap [ DONE] at the top right of the screen.

Deleting an event

1. Tap the event you want to delete.
2. Tap  followed by [OK].

Note

- When you share the schedule on Google Calendar, choose the people with whom you share it very carefully to prevent your schedule from being disclosed to undesired users.
- If your calendar is not synced with Google Calendar automatically, tap [ Settings] followed by [Accounts & sync], and make sure the switch at the top right of the screen is set to [ON].
- If your calendar is set to sync with Google Calendar automatically and you change the schedule on a computer or other devices, your tablet device will connect with Google Calendar automatically. This may cause unexpected communications charges.

▶ Troubleshooting

Preparations

Parts and Controls

Basic Operations

Connections

Other Operations

Apps

Announcements

Browsing Websites

The Browser app lets you access and browse websites on the Internet. You can display/switch between multiple websites by using tabs.

1. Tap [ Apps & Widgets] - [ Browser].

The Browser app starts.

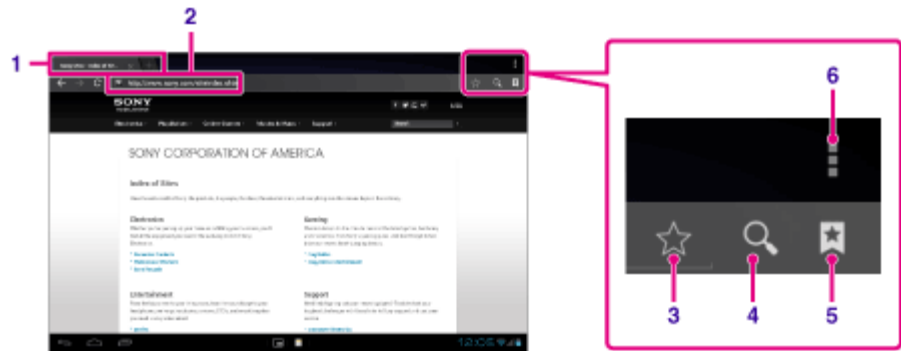

Display on the screen		Description
1	Tab	Allows you to add a tab to browse multiple websites by switching between tabs.
2	Address bar	Allows you to input the address (URL) of the desired website. The on-screen keyboard is displayed when you tap the address bar.
3	Add bookmark	Adds the website that you are browsing to the bookmarks.
4	Search	Allows you to input a keyword to search for on the web. The on-screen keyboard is displayed when you tap the search button.
5	Bookmark/History	Allows you to select a website to browse from the bookmarks or access the access history.
6	Option menu	Makes detailed settings such as switching to the Browser in Small Apps, etc.

2. Tap the address bar on the browser.
The on-screen keyboard is displayed.
3. Input the address (URL) of the desired website, and tap the  key.

Note

- If the content does not display correctly, tap [Settings] followed by [Advanced] in the  (Option menu), then tap [Enable Quick view] to remove the check mark.
- Certain websites may not be displayed because the browser does not support the photo/movie formats or plug-ins used by the website.
- You can launch the browser using the Small Apps feature. In this case, the following functions are not supported.
 - Playing back flash content

- Browsing websites by using tabs
- Bookmarks and access histories

Hint

- You can search the Internet by inputting a keyword or phrase instead of the address (URL) in step 3.
- If the address bar is not displayed at the top of the screen, tap the tab.
- You can copy or search text from the menu that is displayed by selecting text on a website or URL.
- If the website is displayed differently from when browsed on a computer, tap  (Option menu) at the top right of the screen and put a check mark in [Request desktop site] in the menu. You can then browse the website as on a computer.
- You can set whether to view as a desktop or mobile site for each tab.

To add/delete a tab

To add a tab, tap  at the right end of the tabs list.

To delete a tab, tap  at the right end inside the tab.

Related Topic

[Selecting Text](#)

[Adding Bookmarks](#)

[Accessing Sites from Bookmarks/Access History](#)

▶ Troubleshooting

Preparations

Parts and Controls

Basic Operations

Connections

Other Operations

Apps

Announcements

Shooting Photos/Movies

You can shoot photos and movies using the built-in front and rear cameras. Various shooting settings such as image size are also available. Location information also can be added to photos.

1. Tap [⋮ Apps & Widgets] - [📷 Camera].

The Camera app starts.



Display on the screen	Description
1 Detailed settings	Makes detailed settings for recording photos or movies.
2 Preview screen	Previews the subject you are aimed at.
3 Camera switching	Switches between the front camera and rear camera.
4 Recording button	Starts recording a photo or movie.
5 Switch recording mode	Switches the recording mode among photo, movie, and panoramic photo.
6 Recording history	Displays thumbnails of recorded photos or movies.

2. Aim the camera to your subject, and tap  to shoot a photo or  to shoot a movie.



For photos: A photo is taken.

For movies: Movie recording starts. Tapping  again stops recording.



Note

- Do not touch the lenses of the built-in cameras. If the lenses become dirty or scratched, image quality may be affected.
- Do not let direct sunlight enter the lenses of the built-in cameras regardless of whether your tablet device is turned on or off. Doing so may cause the camera to malfunction.

Hint

- The rear camera is equipped with an auto-focus function. After you tap , a photo is shot when the subject comes into focus.
- In order to add location information to the photos, GPS must be enabled or your tablet device must be connected to the network when you take photos [\[Details\]](#).
- You can also view pictures you took and media from apps you play back.
- The focus function allows you to focus the part you tap on the touch panel and select a mode.
- You can also take a picture while taking a movie by tapping .

Shooting Panoramic Photos

1. Start the Camera app.
2. Tap  at the right side of the screen.
3. Point the camera at the edge of the subject, and tap .

Panoramic photo recording starts. Pan or tilt the camera to the opposite end of the subject, and tap  again to stop recording.

Hint

- When you hold your tablet device sideways, you can shoot landscape panoramic photos. When you hold your tablet device upright, you can shoot portrait panoramic photos.

Ending the Camera app

Tap  displayed on the status bar at the bottom left of the screen. If the status bar is not displayed, tap the bottom left of the screen once.

Related Topic

[Notes on Recorded Photos/Movies](#)

▶ Troubleshooting

Preparations

Parts and Controls

Basic Operations

Connections

Other Operations

Apps

Announcements

Registering Contacts

You can register names, phone numbers, addresses, etc. as frequently used contacts. By registering your Google account, you can sync People with Gmail Contacts, making your contacts even more handy.

If using Microsoft Exchange Server, you can manage your work contacts by connecting to Microsoft Exchange Server.

1. Tap [⋮ Apps & Widgets] - [👤 People].

The People app starts.

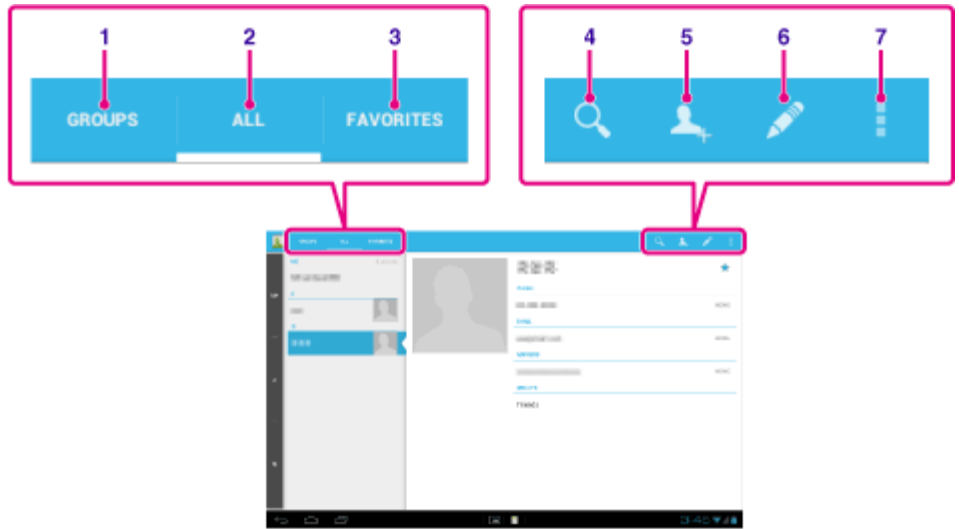

Display on the screen		Description
1	GROUPS	Displays the groups of contacts.
2	ALL	Displays all contacts.
3	FAVORITES	Displays the contacts you registered as FAVORITES.
4	Search	Searches for a contact.
5	New contact	Registers a new contact.
6	Edit contact	Edits a selected contact.
7	Option menu	Makes detailed settings such as sharing contacts with other apps or deleting the contacts.

2. Tap [ALL] at the top left of the screen.

3. Tap 👤.

4. Input the data, and tap [✅ DONE].

The contact is registered.

Hint

- The contact can also be registered by tapping  (Back) at the bottom left of the Home screen in step 3. When you tap  DISCARD], the data you are editing is discarded.

To edit contacts

Tap the contact you want to edit, and then tap  at the top right of the displayed screen.

To delete contacts

Tap the contact you want to delete, and then tap  (Option menu) - [Delete].

To switch what contacts are displayed

Tap  (Option menu) - [Contacts to display] - (the account), and you can switch between the contacts lists of individual accounts. You can also specify all accounts or multiple accounts.

Note

- If your contacts are not synced with Google contacts automatically, tap  Settings] followed by [Accounts & sync], and check that the switch at the top right of the screen is set to [ON].

Related Topic

[Grouping/Joining Contacts](#)

[▶ Troubleshooting](#)[Preparations](#)[Parts and Controls](#)[Basic Operations](#)[Connections](#)[Other Operations](#)[Apps](#)[Announcements](#)

Displaying the Clock

The clock is easy to see even from a distance, and it has a background that changes according to the time.

1. Tap [ Apps & Widgets] - [ Desk clock].

The Desk clock app starts and the digital clock is displayed.

Tapping the icons allows you to do the following operations.



: Sets the alarm.



: Plays slide show.



: Plays back music.



: Returns to the Home screen.

Hint

- The time set for the alarm is displayed on the screen.
- Tap anywhere on the screen to change the screen brightness between two levels.

▶ Troubleshooting

Preparations

Parts and Controls

Basic Operations

Connections

Other Operations

Apps

Announcements

Configuring an E-mail Account

The e-mail account you usually use on your computer can be used on the tablet device. If you register multiple e-mail accounts, you can handle e-mails of all the accounts at the same time. You can also search or sort received e-mail messages.

1. Tap [⋮ Apps & Widgets] - [✉ Email].

The Email app starts and the screen to set an account is displayed.

2. Input your e-mail address and password, and tap [Next].

3. Follow the on-screen instructions to set the e-mail account.

When setting is complete, the e-mail list screen is displayed.



Display on the screen		Description
1	Selection	Allows you to select e-mails by tapping check boxes to move e-mails to another folder or delete them together.
2	Compose an e-mail	Composes and sends an e-mail [Details] .
3	Search	Searches for e-mails from the e-mail list.
4	Refresh	Receives e-mails.
5	Option menu	Sorts e-mails, adds/removes accounts, etc.

Hint

- You can set for each account the number of received e-mails to be put in a folder by tapping [⋮ (Option menu)] - [Settings] - (e-mail account you want to change settings of) - [Messages per folder] on the e-mail list screen.
- Searches cover the subject, sender, and e-mail body of all the e-mails saved on the server.
- Results are displayed 10 at a time from the latest e-mails. To search for older e-mails, tap

[Load more messages].

Note

- Ask your network administrator, etc. about how to connect to Microsoft Exchange Server.
- For details on setting an e-mail address supplied by an Internet provider, refer to the provider's website, support center, etc.

Related Topic

[Composing/Sending an E-mail](#)

[Receiving/Deleting E-mails](#)

▶ [Troubleshooting](#)

Preparations

Parts and Controls

Basic Operations

Connections

Other Operations

Apps

Announcements

Movies

See the help for this app to find out how to use the app.

- English
http://helpguide.sony.net/apps_td/movies/h_at/gb/
 - French
http://helpguide.sony.net/apps_td/movies/h_at/fr_ca/
 - Spanish
http://helpguide.sony.net/apps_td/movies/h_at/es_la/
 - Portuguese
http://helpguide.sony.net/apps_td/movies/h_at/pt_br/
-

▶ [Troubleshooting](#)

Preparations

Parts and Controls

Basic Operations

Connections

Other Operations

Apps

Announcements

WALKMAN

See the help for this app to find out how to use the app.

- English
http://helpguide.sony.net/apps_td/walkman/h_at/gb/
 - French
http://helpguide.sony.net/apps_td/walkman/h_at/fr_ca/
 - Spanish
http://helpguide.sony.net/apps_td/walkman/h_at/es_la/
 - Portuguese
http://helpguide.sony.net/apps_td/walkman/h_at/pt_br/
-

▶ Troubleshooting

Preparations

Parts and Controls

Basic Operations

Connections

Other Operations

Apps

Announcements

Album

See the help for this app to find out how to use the app.

- English
http://helpguide.sony.net/apps_td/album/h_at/gb/
 - French
http://helpguide.sony.net/apps_td/album/h_at/fr_ca/
 - Spanish
http://helpguide.sony.net/apps_td/album/h_at/es_la/
 - Portuguese
http://helpguide.sony.net/apps_td/album/h_at/pt_br/
-

▶ Troubleshooting

Preparations

Parts and Controls

Basic Operations

Connections

Other Operations

Apps

Announcements

Playing Photos/Videos

The Gallery app allows you to show or play photos and video on your tablet device or Picasa web albums. You can also easily post photos to online services to share them.

You can display detailed information as well as sort or filter your photos and videos.

1. Tap [⋮ Apps & Widgets] - [🖼️ Gallery].

The Gallery app starts.

2. Tap albums or thumbnails to select the photos or videos you want to play.
The selected photos or videos are played on the playback screen.

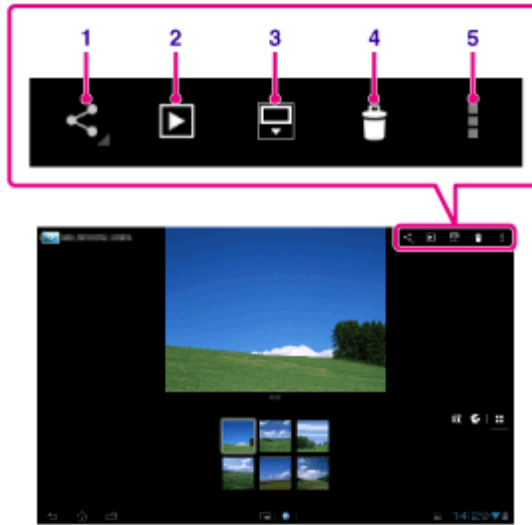

Display on the screen		Description
1	Share	Selects the service you want to use to share photos or movies and posts them.
2	Slide show	Starts slide show playback.
3	Switch display area of photos	Switches the display area of photos.
4	Delete	Deletes the selected photo.
5	Option menu	Sets or adjusts settings such as editing photos.

Hint



- You can play photos or videos stored in Picasa web albums. If you set to sync with Picasa web albums available with the Google account that you set with the Settings app, the Picasa web albums will appear in your album list.
- Using the menu at the top right of the screen, you can sort photos or videos by details such as the time or place they were taken.
- By tapping and holding thumbnails in succession, you can select multiple photos or videos.

- You can control playback on the playback screen.

To display photos full-screen

Tap [Fill display area] from the option menu of the photo playback screen. To cancel full-screen view, tap [Fit to display area].

To display shooting location

Tap  or  with the display area not expanded. If the photo has information on where it was shot, a map appears with the location indicated on the map. To return to the thumbnails, tap .

Hint

- You can shoot photos that include location information using the built-in cameras.

Playing back photos automatically (slide show)

1. Select albums or thumbnails for photos you want to play back as a slide show, and then tap .
Slide show playback starts.

Related Topic

[Sharing Photos/Videos](#)



[Editing Photos](#)

[▶ Troubleshooting](#)[Preparations](#)[Parts and Controls](#)[Basic Operations](#)[Connections](#)[Other Operations](#)[Apps](#)[Announcements](#)

Importing/Exporting Contents from an SD Memory Card

The File transfer app enables you to import/export data between the internal memory of the tablet device and an SD memory card.

To import/export data between the internal memory of the tablet device and an SD memory card

1. Insert an SD memory card into the SD memory card slot.
 2. Tap [ Apps & Widgets] - [ File transfer].
The File transfer app starts.
 3. Tap the file or folder you want to transfer to add a check mark to it.
 - Tapping the recording media icon switches between the screens for importing and exporting.
 - To move to a folder, tap the icon of the folder in the list. To display detailed information about the folder, tap and hold the icon of the folder.
 4. To select a destination folder, tap  in [Import to] or [Export to].
If you do not select a folder, the file is transferred to the [transferred] folder on the media.
 5. Tap  or .
- File transfer starts.

Note

- Do not remove the media during data transfer.

Related Topic

[Checking the Free Space](#)

[Supported Formats](#)

[Inserting/Removing an SD Memory Card](#)

▶ Troubleshooting

Preparations

Parts and Controls

Basic Operations

Connections

Other Operations

Apps

Announcements

Registering the Remote Control

The tablet device can be used as a remote control by using the infrared remote (IR) control feature.

By registering multiple remote control codes, you can operate multiple devices with one tablet device.

Frequently used operations such as changing the volume or channels can be performed by intuitive gestures.

1. Tap [⋮ Apps & Widgets] - [📺 Remote control].

The Remote control app starts.

2. Tap [Register device] or [+ Register device].

3. Tap [Easy registration].

4. Register your tablet device as a remote control by following the on-screen instructions. Execute [Remote control test] if needed.

When you finished registration, the screen returns to the device list screen of step 2. Tap the name of registered device to display the remote control screen.



Display on the screen		Description
1	Switch between full or gesture remote control feature	Switches the remote control feature between the “gesture” remote control feature operated by gestures such as flicking or sliding and the “full” remote control feature operated by tapping [Details].
2	Switch the registered remote controls	Switches the registered remote control by tapping the icon at the left and right of the currently controlled device.
3	Configure macro	Registers the macro that allows you to perform multiple device commands in succession just by tapping the button.
4	Option menu	Sets detailed settings such as editing or deleting the registered devices.
5	Registered macro	Tap to run the registered macro.

Hint

- This app can use as Small Apps.
- You can configure the skin setting by tapping [Change skin] on the  (Option menu). You can configure the skin separately for each registered device.
- If the category or manufacturer is not displayed, allow your tablet device to learn the remote control signal then register it.
- Two or more devices may be displayed depending on the category or manufacturer. If more than one device is displayed, test the remote control operation with each of remote control displayed and select the one that works correctly.

To register as a remote control for another device

Tap  (Back), and then tap [ Register device] on the device list screen.

Learning the remote control signal and registering it

If the category or manufacturer of the device is not displayed at [Easy registration], register the remote control as follows.

1. Start the Remote control app.
2. Tap [ Register device] or [Register device].
3. Tap [Learn from a remote control].
4. Select the category.
The screen for learning remote control commands is displayed.
5. Tap the button to which you want the command learned.
6. When the menu screen is displayed, tap [Learn remote command].
7. Bring the IR transmitter of the remote control to be registered close to the IR data port of your tablet device as shown in the following illustration, and then tap [Start].

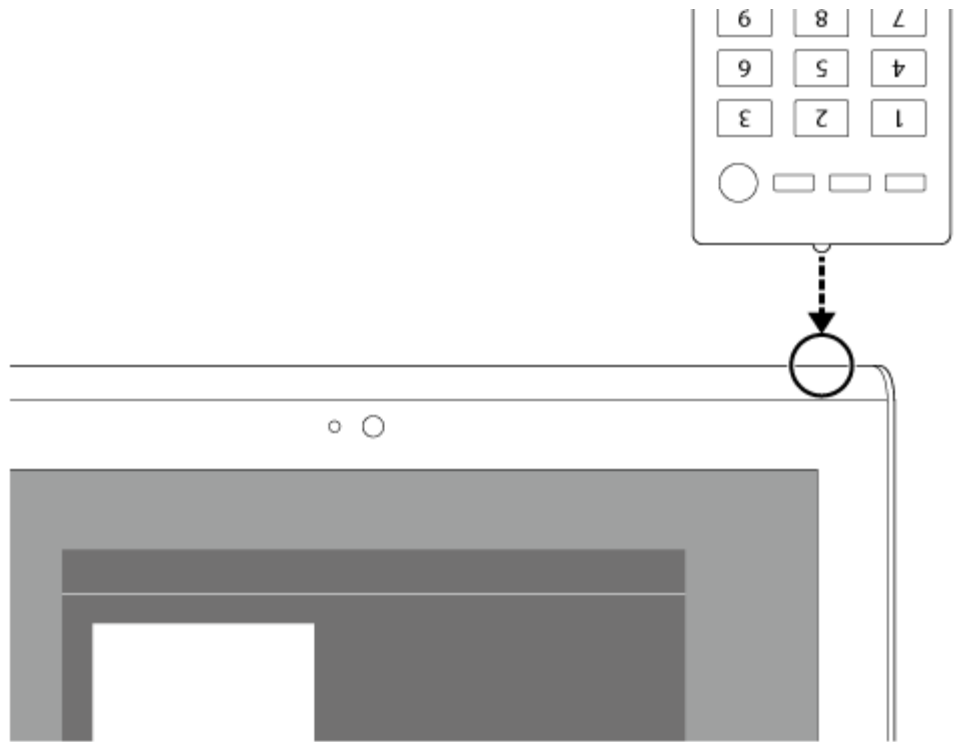

8. Press the button to be learned by the remote control.
When learning is finished, the registered button is highlighted on the screen.
To learn more buttons, repeat steps 5 to 8.
9. Tap [Next], select gesture by following the on-screen instructions, and then tap [Finish].
When the button is registered, the screen returns to the device list screen of step 2. Tap the name of registered device to display the remote control screen.

Note

- Make sure that the remote control to be registered is an IR remote control.
- Your tablet device may not be able to learn some remote control operations depending on the kind of IR remote control. This does not indicate a malfunction.
- If you cannot register in step 7, the IR data port of your tablet device may not be facing that of the remote control. Check the position of the IR data port of your tablet device, then try again to match the IR data ports of the tablet device and remote control at a distance of about 20 mm to 50 mm (0.8 in. to 2 in.).

Related Topic

[Using “Small Apps”](#)

[Programming Operations in the Remote Control \(Macro Function\)](#)

▶ Troubleshooting

Preparations

Parts and Controls

Basic Operations

Connections

Other Operations

Apps

Announcements

Socialife

See the help for this app to find out how to use the app.

- English
http://helpguide.sony.net/apps_c/socialife/h_at/gb/
 - French
http://helpguide.sony.net/apps_c/socialife/h_at/fr1/
 - Spanish
http://helpguide.sony.net/apps_c/socialife/h_at/es1/
 - Portuguese
http://helpguide.sony.net/apps_c/socialife/h_at/pt2/
-

[▶ Troubleshooting](#)[Preparations](#)[Parts and Controls](#)[Basic Operations](#)[Connections](#)[Other Operations](#)[Apps](#)[Announcements](#)

Checking the Wi-Fi Connection



The Wi-Fi checker app enables you to check the Wi-Fi connection of your tablet device when a connection problem occurs.

1. Tap [ Apps & Widgets] - [ Wi-Fi checker].

Wi-Fi checker app starts.

2. Tap [Test] at the top right of the screen to start checking the connection.
Items are checked in succession, and assumed causes and remedies are displayed.

Hint

- If you tap [ SETTINGS] at the top right of the screen, you can display the settings screen for Wi-Fi connection. Use [] to return to the Wi-Fi checker app. If you tap [] to display the Home screen, the settings screen appears when you start the Wi-Fi checker app the next time.

Related Topic

[Connecting to Wi-Fi](#)

▶ Troubleshooting

Preparations

Parts and Controls

Basic Operations

Connections

Other Operations

Apps

Announcements

Reading Digital Books

Carry your favorite digital books on your tablet device. The intuitive design is ideal for on-the-go reading, allowing you to bookmark, highlight and adjust font size as you read. You can even sync bookmarks and highlighted items with other compatible devices. Purchasing content is made easy by the online Reader(TM) Store. In countries where you cannot purchase from the Reader(TM) Store, you can still enjoy books on your tablet device by loading them from a memory card (books without copy-protection only).

- Bookmarking and highlighting
- Adjustable font sizes
- Intuitive navigation
- Syncing with other compatible devices

1. Tap [⋮] Apps & Widgets] - [📖 Reader by Sony].

The Reader by Sony app starts.

Note

- Reader (TM) Store may not be available in some countries/regions.
- Reader (TM) Store uses Adobe DRM, and an Adobe ID is required to authorize your tablet for viewing protected content.
- If you do not have an Adobe ID already, Reader (TM) Store will create one using the same email address and password you used to create a Reader (TM) Store account.
- If you already have an Adobe ID, you may be prompted to provide the appropriate email and password to authorize your tablet.
- eBooks purchased at Reader (TM) Store will automatically be displayed in your library.
- With the Reader by Sony app on your tablet, you can enjoy books other than those from the Reader (TM) Store EPUB or PDF eBooks by loading them via USB or SD card or by downloading the content directly from your tablet's browser.

Support information

For customers in the U.S. and Canada only

<http://ebookstore.sony.com/help>

Related Topic

[Confirming Download or Update Information on the Status Bar](#)

[Importing/Exporting Contents from an SD Memory Card](#)

▶ Troubleshooting

Preparations

Parts and Controls

Basic Operations

Connections

Other Operations

Apps

Announcements

Scrapbook

See the help for this app to find out how to use the app.

- English
http://helpguide.sony.net/apps_td/scrapbook/h_at/gb/
 - French
http://helpguide.sony.net/apps_td/scrapbook/h_at/fr1/
 - Spanish
http://helpguide.sony.net/apps_td/scrapbook/h_at/es1/
 - Portuguese
http://helpguide.sony.net/apps_td/scrapbook/h_at/pt2/
-

[▶ Troubleshooting](#)

[Preparations](#)

[Parts and Controls](#)

[Basic Operations](#)

[Connections](#)

[Other Operations](#)

[Apps](#)

[Announcements](#)

Using Sony Select

Sony Select allows you to access a website that introduces a select range of apps appropriate for use with your tablet device.

1. Tap [ Apps & Widgets] - [ Sony Select].

The browser starts and displays the website.

Note

- To download apps, Google account settings are required.
 - Charges apply for some apps.
 - A large volume of data is transferred when downloading and updating apps.
-

[▶ Troubleshooting](#)

Preparations

Parts and Controls

Basic Operations

Connections

Other Operations

Apps

Announcements

Registration

The Registration app allows you to register your tablet device with Sony. Registering your tablet device allows us to maintain a record of your purchase in case of loss or theft and to inform you of important product updates and promotions. It will also help us design products that meet your specific needs.

1. Tap [ Apps & Widgets] - [ Registration].

The Registration app starts.

2. Read the End User License Agreement, and tap [Accept] to continue if you accept the agreement. Otherwise, tap [Decline] to exit the app.
3. Enter your personal information.
Hint
 - Only the fields with * are required. All other information is optional.
4. By default, "Yes, I would like to receive information from Sony Electronics on products, services and special offers that may be of interest to me." is checked. If you prefer not to receive future information from Sony Electronics, tap the box to remove the check mark.
5. Tap [Submit] to submit your registration information to Sony.

Note

- This app is available in the United States only.
- If you would like to read additional information regarding Sony's privacy policy, please tap on [Privacy Policy].

[▶ Troubleshooting](#)

[Preparations](#)

[Parts and Controls](#)

[Basic Operations](#)

[Connections](#)

[Other Operations](#)

[Apps](#)

[Announcements](#)

Registering Your Tablet Device

Sony recommends you register your tablet so we can provide better customer support.

1. Tap [ Apps & Widgets] - [ Product registration].

The browser starts and Sony product registration site appears.

2. Register your tablet device by following the on-screen instructions.

Hint

- In some countries/regions, you will be asked to present information such as leaflets supplied with the tablet device, the warrantee or a receipt issued at the store where you purchased the tablet device. Please keep these documents handy.

Note

- This app or service may not be available in some countries/regions.
-

▶ [Troubleshooting](#)

[Preparations](#)

[Parts and Controls](#)

[Basic Operations](#)

[Connections](#)

[Other Operations](#)

[Apps](#)

[Announcements](#)

Using the “Video Unlimited” Video Delivery Service

Video Unlimited brings you a new world of entertainment on your tablet. Now you can download your favorite videos to your tablet device and watch them anytime, anywhere.

1. Tap [ Apps & Widgets] - [ Video Unlimited].

Note

- This app or service may not be available in some countries/regions.
- Internet usage fees may apply to use of this service. You are responsible for all applicable Internet fees. Contact the carrier you have a subscription with for more information.
- You can browse the content without signing in, however please make sure that you have a registered account to purchase and download contents.
- Your tablet device must be connected to a network using Wi-Fi or mobile communications (SGPT13) to use the preview feature.
- Your tablet device must be connected to a network using Wi-Fi to download the content you have purchased. Content you have purchased can be downloaded from [ Download List].
- To download content, your current location must be the same as the country/region for your account.
- Check that there is enough free space to download the content.

Support information

United States

http://us.support.sonyentertainmentnetwork.com/app/home/?locale=en_US

Canada (Français)

<http://qriocity-fr-ca.custhelp.com/app/home>

Canada (Anglais)

http://qriocity-en-us.custhelp.com/app/home/?locale=en_CA

▶ Troubleshooting

Preparations

Parts and Controls

Basic Operations

Connections

Other Operations

Apps

Announcements

Using the “Music Unlimited” Music Delivery Service

Music Unlimited is a music service available on Sony Entertainment Network. You can choose your favorite music from a variety of music content and listen to it whenever you want. Upload your personal library to access it anytime, anywhere as well as to discover new favorites from automatic recommendations based on your unique listening habits. Automatic recommendations allow you to broaden your musical interests.

- Music on Demand – Listen to any song you want, when you want it
- Millions of songs, from the latest hits to classic favorites
- Radio channels that span genres, moods, and eras
- No ads and unlimited skips
- Ability to sync and play from your personal collection
- Access from a variety of devices

1. Tap [ Apps & Widgets] - [ Music Unlimited].

Note

- This app or service may not be available in some countries/regions.

Support information

United States

http://us.support.sonyentertainmentnetwork.com/app/home/?locale=en_US

Canada (Français)

<http://qriocity-fr-ca.custhelp.com/app/home>

Canada (Anglais)

http://qriocity-en-us.custhelp.com/app/home/?locale=en_CA

▶ [Troubleshooting](#)

[Preparations](#)

[Parts and Controls](#)

[Basic Operations](#)

[Connections](#)

[Other Operations](#)

[Apps](#)

[Announcements](#)

PlayMemories Online

Your Memories, at your Fingertips.

Enjoy your photos and videos across your favorite devices, instantly!

Features

- **Works with Multiple Devices**
Enjoy your favorite memories across your smartphone, tablet, computer, "BRAVIA," and "S-Frame."
- **Easy to Upload**
Effortlessly upload photos and videos to your PlayMemories Online account and enjoy them on your favorite devices, instantly!
- **Works with Video**
Supports videos too! Videos are automatically converted for seamless viewing across your favorite devices.
- **Simple to Use**
Your photos and videos are automatically prepared for your favorite devices. No hassle, just simple.
- **Share Privately**
Privately share your favorite memories with friends and family using Albums and Postcards.

Note

- This app or service may not be available in some countries/regions.
- "PlayMemories Online" service offering 5GB of FREE storage for photos and videos.

Support information

- **United States**
1-877-428-5608
http://esupport.sony.com/US/perl/support-info.pl?template_id=1&info_id=984
- **Canada(English)**
1-877-428-5608
http://esupport.sony.com/CA/perl/support-info.pl?template_id=1&info_id=984
- **Canada(French)**
1-877-428-5608
http://esupport.sony.com/CA/perl/support-info.pl?template_id=1&info_id=985

[▶ Troubleshooting](#)

[Preparations](#)

[Parts and Controls](#)

[Basic Operations](#)

[Connections](#)

[Other Operations](#)

[Apps](#)

[Announcements](#)

Xperia Link

You can connect your tablet to internet by using tethering function of Xperia(TM) smartphone*. Tethering settings of smartphone can be controlled from tablet by remote control, so you can connect your tablet to internet with your smartphone in bag or pocket.

* You need Xperia(TM) smartphone with tethering capability and "Xperia Link" application.

▶ Troubleshooting

Preparations

Parts and Controls

Basic Operations

Connections

Other Operations

Apps

Announcements

PSM

This PSM (PlayStation(R)Mobile for Android) app allows you to access PlayStation(R)Store to purchase various content including games. You can also use it to manage or run purchased content.

Note

- This app or service may not be available in some countries/regions.
- You will no longer be able to run purchased content if you uninstall this application.
- A PSN or SEN sign-in ID is needed to purchase games from PlayStation(R)Store.
- Your tablet device must be connected to a network using Wi-Fi or mobile communications (SGPT13) to download purchased content.
- Check that there is enough free space to download the content.

Support information

- U.S.A./Canada
<http://us.playstation.com/support/>
- United Kingdom
<http://uk.playstation.com/support/>
- Germany
<http://de.playstation.com/support/>
- Spain
<http://es.playstation.com/support/>
- France
<http://fr.playstation.com/support/>
- Italy
<http://it.playstation.com/support/>
- Australia
<http://au.playstation.com/support/>

[▶ Troubleshooting](#)

[Preparations](#)

[Parts and Controls](#)

[Basic Operations](#)

[Connections](#)

[Other Operations](#)

[Apps](#)

[Announcements](#)

Using “MediaRemote”

MediaRemote is a Wi-Fi remote control app that can be used with devices such as Sony BRAVIA TVs and Blu-ray disc players. Enabling more than just conventional remote control operations, MediaRemote has various functions such as keyboard entry and content information display, giving you greater utility and enjoyment with Sony devices.

Note

- Be careful of home network security when you enter personal information.

Preparing MediaRemote

1. Connect the Sony device to your home network.
For details on how to connect, see the operating instructions supplied with the device and Wi-Fi router.
2. Connect your tablet device to the same home network that the Sony device is connected to.
3. Register your tablet device on the Sony device.
For details on settings, see the operating instructions supplied with the device.

See the Help in the MediaRemote app to find out how to use that app.

▶ [Troubleshooting](#)

[Preparations](#)

[Parts and Controls](#)

[Basic Operations](#)

[Connections](#)



[Other Operations](#)

[Apps](#)

[Announcements](#)

Changing the Settings

Various settings of your tablet device can be configured in the settings menu.

1. Tap [ Apps & Widgets] - [ Settings] and the desired items.
2. Tap the individual menu items to configure settings.

The menu items are as follows:

- WIRELESS & NETWORKS
 - Wi-Fi: Turning on/off the Wi-Fi function [[Details](#)], setting Wi-Fi [[Details](#)].
 - Bluetooth: Turning on/off the Bluetooth function [[Details](#)], pairing [[Details](#)].
 - Data usage: Checking the data usage status.
 - More...: Setting Airplane mode, VPN, etc.
- DEVICE
 - Sound: Setting the notification sound, tap sound (operation sound), etc.
 - Display: Settings such as screen brightness [[Details](#)], power save mode, Auto HDMI output, time that elapses before the screen turns off (goes to sleep) [[Details](#)], and font size.
 - Storage: Checking the capacity of the internal memory of the tablet device or SD memory card.
 - Battery: Checking the remaining battery level and operating time.
 - Apps: Checking the installed app information.
- PERSONAL
 - Accounts & sync: Settings for synchronization of accounts such as e-mail [[Details](#)].
 - Location services: Settings to identify your present location [[Details](#)].
 - Security: Security settings such as the Screen lock function [[Details](#)].
 -  Language & input: Settings for the language used in menus and the keyboard [[Details](#)].
 - Backup & reset: Making a backup copy of data and initializing [[Details](#)].
- SYSTEM
 - Cradle: Operation settings when using the cradle.
 - Date & time: Setting the date & time and display.
 - Accessibility: Setting the text-to-speech function, etc.
 - About tablet: Checking the Android version.

Note

- Display may be distorted with some apps if you set [Font size] to [Large] or [Huge] in [Display]. If that occurs, set [Font size] to [Normal].
-

[▶ Troubleshooting](#)

[Preparations](#)

[Parts and Controls](#)

[Basic Operations](#)

[Connections](#)

[Other Operations](#)

[Apps](#)

[Announcements](#)

Using the Calculator

You can use your tablet device as a calculator. In addition to the four arithmetic operations of addition, subtraction, multiplication and division, trigonometric function, exponent function, logarithm, etc. are available.

1. Tap [ Apps & Widgets] - [ Calculator].

The Calculator app starts.

Hint

- This app can use as Small Apps.

Related Topic

[Using "Small Apps"](#)

▶ Troubleshooting

Preparations

Parts and Controls

Basic Operations

Connections

Other Operations

Apps

Announcements

Using "Gmail"

You can use Gmail on your tablet device if you register your Google account on your tablet device.

1. Tap [ Apps & Widgets] - [ Gmail].

Gmail starts.



Display on the screen		Description
1	Compose an e-mail	Composes and sends an e-mail.
2	Search	Searches for e-mails from e-mail list.
3	Refresh	Check for new e-mails.
4	Option menu	Sets detailed settings such as managing labels or configuring general settings for Gmail.

Note

- To see details on how to use Gmail, tap  (Option menu) - [Help].

▶ Troubleshooting

Preparations

Parts and Controls

Basic Operations

Connections

Other Operations

Apps

Announcements

Crackle

Watch full-length uncut Hollywood movies & TV shows on your tablet device. 250 movies and over 1,000 TV episodes are available on your tablet device, all on demand.

Note

- This app or service may not be available in some countries/regions.

Support information

<http://www.crackle.com/support/help.aspx>

android@crackle.com

[▶ Troubleshooting](#)

[Preparations](#)

[Parts and Controls](#)

[Basic Operations](#)

[Connections](#)

[Other Operations](#)

[Apps](#)

[Announcements](#)

Zinio

Zinio is the premier app for magazines on your tablet, giving readers immediate access to thousands of global titles. Read and download single issues or subscriptions of your favorite magazines and sync your library to your home computer, smart phone and tablet seamlessly. Keep up with trending topics and stories from magazines like Rolling Stone, The Economist, Hello!, US Weekly, T3, Macworld, Travel + Leisure and many more.

Key features

- Thousands of top magazines in the world's largest newsstand.
- Full-color pages or text-only mode.
- Interactive features, rich media, and exclusive multimedia content in select magazines.
- Full subscriptions or single issues available so you can choose what you want.
- Sync your library instantly to your other mobile devices or your home computer.

Read what you like, anytime and anywhere.

Find us on Twitter ([@zinio](#)) or Facebook ([/zinio](#)), or check out the Zinio blog at [blog.zinio.com](#).

Support information

help@zinio.com

<http://www.zinio.com/help>

[▶ Troubleshooting](#)

[Preparations](#)

[Parts and Controls](#)

[Basic Operations](#)

[Connections](#)

[Other Operations](#)

[Apps](#)

[Announcements](#)

Evernote

Evernote turns your tablet into an extension of your brain.

Evernote is an easy-to-use, free app that helps you remember everything across all of your tablet. Stay organized, save your ideas and improve productivity. Evernote lets you take notes, capture photos, create to-do lists, record voice reminders--and makes these notes completely searchable, whether you are at home, at work, or on the go.

Key features

- Sync all of your notes across the computers and devices you use
- Create and edit text notes, to-dos and task lists
- Save, sync and share files
- Search for text inside images
- Organize notes by notebooks and tags
- Email notes and save tweets to your Evernote account
- Connect Evernote to other apps and products you use
- Share notes with friends and colleagues via Facebook and Twitter

Premium features

- Take notebooks offline to access them anytime
- Allow others to edit your notebooks
- Add a PIN lock to your Evernote app

Support information

<http://evernote.com/contact/support/>

[▶ Troubleshooting](#)

[Preparations](#)

[Parts and Controls](#)

[Basic Operations](#)

[Connections](#)

[Other Operations](#)

[Apps](#)

[Announcements](#)

Skype

Make free Skype-to-Skype video calls, and call phones at Skype rates on the move.

Make free voice and video calls to anyone else on Skype, whether they're on an Android or PC, as well as IMs to your friends and family.

Features

- Skype to Skype IMs, video and voice calls are free* over mobile network or Wi-Fi.
- Make low-cost calls and SMS to mobiles or landlines from your Android.
- Send pictures, videos and files to any of your contacts.
- Enjoy high-quality sound when you call anyone else on Skype.
- Talk face to face or show what you're seeing with front and rear-facing cameras.

* Operator data charges may apply. We recommend using an unlimited data plan or WiFi connection.

Support information

<http://support.skype.com/>

[▶ Troubleshooting](#)

[Preparations](#)

[Parts and Controls](#)

[Basic Operations](#)

[Connections](#)

[Other Operations](#)

[Apps](#)

[Announcements](#)

OfficeSuite Viewer

View and share Microsoft Word, Excel, and PowerPoint and PDF files and attachments on your tablet with a single complete feature-rich mobile Office solution. The software utilizes the most commonly used desktop document formats and also includes a File Browser and integration with Google Docs, DropBox, Box and SugarSync to help you manage your local, remote files and email attachments. OfficeSuite Pro is an essential productivity application offering greater office efficiency than ever anywhere, anytime.

Support information

<http://www.mobisystems.com/support.html>

support@mobisystems.com

▶ Troubleshooting

Preparations

Parts and Controls

Basic Operations

Connections

Other Operations

Apps

Announcements

AccuWeather

AccuWeather forecasts for 2.7 million locations, supports 27 languages, and has descriptive weather graphics that will appeal to your tablet. With GPS and interactive Google Maps, this free weather app makes it easy to get detailed and current forecasts and news from the most trusted name in weather.

Features include severe weather notices, home screen widgets, animated radar, satellite, special lifestyle and health forecasts, display options, and much more:

- Animated radar for North America, satellite and interactive Google Maps for locations worldwide, and current, broadcast-quality weather videos.
- Severe weather notices for events such as, snow, ice, rain, wind, and thunderstorms.
- Hourly forecasts for the next 24 hours, plus day and night forecasts for the next fifteen days.
- Details including, humidity percentages, visibility, pressure, dew point, precipitation and amounts, UV index, wind and wind gust speed, wind direction, and AM and PM times for sunrise and sunset.
- RealFeel - AccuWeather's proprietary weather forecasting system that takes into account multiple weather conditions to determine how the local temperature actually feels, which may be warmer or colder than the temperature depending on these conditions.
- Special lifestyle weather and health forecasts, as well as conditions for specific outdoor activities and sports, such as golfing, fishing, and jogging, and health-related weather forecasts, such as flu and migraine headache forecasts.
- AccuWeather widgets for your tablet's home screen that link directly to the full app.

Note

- AccuWeather Application Permissions
<http://www.accuweather.com/en/privacy>
<http://www.accuweather.com/en/legal>

Support information

(814) 235-8650

<http://www.accuweather.com/en/contact>

support@accuweather.com

[▶ Troubleshooting](#)

[Preparations](#)

[Parts and Controls](#)

[Basic Operations](#)

[Connections](#)

[Other Operations](#)

[Apps](#)

[Announcements](#)

Top HD Games - Gameloft

Download high quality games to your Android tablet from the top HD Games at Gameloft's online store. Choose from hit titles such as Asphalt 6, Real Football 2011, and N.O.V.A. 2 - Near Orbit Vanguard Alliance.

Support information

<http://support.gameloft.com/>

support@gameloft.com

- U.S.A.
1-800-910-3186, 1-800-913-6828, 1-800-961-6744 (09:00-18:00 Monday-Friday)
 - Canada
1-800-910-3186, 1-800-913-6828, 1-800-961-6744 (09:00-18:00 Monday-Friday)
 - Mexico
1-800-681-9573, 1-800-681-9272 (09:00-18:00 Monday-Friday)
 - Chile
2-570-8607 (09:00-18:00 Monday-Friday)
 - Colombia
1-800-710-2071 (09:00-18:00 Monday-Friday)
 - Panama
e-mail support only
 - Argentina
0800-222-1416 (09:00-18:00 Monday-Friday)
 - Brazil
55-2139560516, 0800-885-5607 (09:00-18:00 Monday-Friday)
 - Venezuela
58-2123357899 (09:00-18:00 Monday-Friday)
 - Peru
e-mail support only
-

[▶ Troubleshooting](#)

[Preparations](#)

[Parts and Controls](#)

[Basic Operations](#)

[Connections](#)

[Other Operations](#)

[Apps](#)

[Announcements](#)

Xperia Games

The Xperia Games blog is your source for all the latest games news on your Xperia(TM) Phone or Xperia(TM) Tablet S. Every week we scour the charts to find the best in gaming, bringing you news, reviews and interviews to help you find the titles you'll love. So whether you are into killing aliens or just killing time, non-stop adrenaline-charged action or maybe just a bit of casual fun you can enjoy with your friends - check out Xperia Games!

Support information

<http://www.sonymobile.com/global-en/support/contact-us/>

- United States
+1 866 766 9374
 - Puerto Rico
web support only
 - Canada
+1 1 866 766 9374
 - Mexico
+1 800 000 4722
 - Colombia
+57 1800 0966 080
 - Panama
web support only
 - Peru
0800 532 38
 - Venezuela
0 800 100 2250
 - Argentina
+54 0800 333 7427
 - Chile
+56 800 646 425
 - Brazil
+55 4001 0444
-

[▶ Troubleshooting](#)

[Preparations](#)

[Parts and Controls](#)

[Basic Operations](#)

[Connections](#)

[Other Operations](#)

[Apps](#)

[Announcements](#)

Netflix

Netflix is the world's leading subscription service for watching TV episodes and movies on your tablet. The Netflix application is designed to deliver the best experience on your tablet anywhere, anytime.

Get the free app as a part of your Netflix membership and you can instantly watch thousands of TV episodes & movies on your tablet.

If you are not a Netflix member then sign up for Netflix and start enjoying immediately on your tablet with our one-month free trial.

How does Netflix work?

- Netflix membership gives you access to unlimited TV shows and movies for one low monthly price.
- With the Netflix app you can instantly watch as many TV episodes & movies as you want, as often as you want, anytime you want.
- You can browse a growing selection of thousands of titles, and new episodes that are added regularly.
- Search for titles and watch immediately on your phone or on an ever expanding list of supported device.
- Rate your favorite shows and movies and tell us what you like so Netflix can help suggest the best titles for you.
- Start watching on one device, and resume watching on another. Check out netflix.com for all the TVs, game consoles, tablets, phones, Blu-ray players and set top boxes on which you can watch Netflix.

Note

- This app or service may not be available in some countries/regions.
- By downloading this application you agree to the Netflix Terms of Use and Privacy Policy, located at www.netflix.com

1-month free Netflix membership offer is available to first time and certain former members and cannot be combined with any other offer. Internet access and valid payment method are required to redeem offer. Netflix will begin to bill your payment method for the Netflix membership fee at the end of the free month unless you cancel prior to the end of the first month. Your Netflix membership is a month-to-month subscription that you can cancel at any time. Go to "Your Account" on the Netflix website for cancellation instructions. No refund or credit for partial monthly subscription periods. The Netflix service is only available in the country where you originally signed up. A device that streams from Netflix (manufactured and sold separately) and broadband Internet connection are required to watch instantly. For complete terms and conditions, please visit <http://www.netflix.com/TermsOfUse>.

Support information

www.netflix.com/support

[▶ Troubleshooting](#)

[Preparations](#)

[Parts and Controls](#)

[Basic Operations](#)

[Connections](#)

[Other Operations](#)

[Apps](#)

[Announcements](#)

Hulu Plus

Hulu Plus. Unlimited Instant Streaming (Subscription Required).

Download the app to enjoy unlimited instant streaming of current hit TV shows with your Hulu Plus subscription. New to Hulu Plus? Try it FREE.

Hulu Plus supports select phones running Android 2.2+ and select tablets running Android 3.0+ in the United States. See below for a complete list of supported devices.

- Watch the full current season of popular shows including Modern Family, The Office, Family Guy, and many others
- Enjoy classic series including Lost and Battlestar Galactica
- Resume watching from where you left off on your TV or other supported device
- Watch over Wi-Fi and mobile network
- Available for \$7.99/month with limited advertising

Use of Hulu Plus is subject to the Hulu Plus Terms of Service: hulu.com/terms

Note

- This app or service may not be available in some countries/regions.

Support information

<http://www.hulu.com/support/>
support@hulu.com

[▶ Troubleshooting](#)

[Preparations](#)

[Parts and Controls](#)

[Basic Operations](#)

[Connections](#)

[Other Operations](#)

[Apps](#)

[Announcements](#)

Totalmovie

Totalmovie is the first service of streaming in Latin America. With Totalmovie you can watch full-length Movies, TV Series and much more.

Download the free Totalmovie App to instantly watch content.

With your subscription, you can enjoy unlimited content in Spanish, English and Portuguese language. The Totalmovie service is now available in more than 40 countries in Latin America.

Not a Totalmovie member? [Subscribe and start your free trial.](#)

Totalmovie Watch whatever you want to watch, whenever you want to, wherever you might be.

Note

- This app or service may not be available in some countries/regions.
- Terms and Conditions
http://www.totalmovie.com/page.php?id=terms_and_conditions
- Privacy Policy
http://www.totalmovie.com/page.php?id=privacy_policy

Support information

http://www.totalmovie.com/page.php?id=contact_us
atencion@totalmovie.com

- Mexico City:
8421.2005
- Mexico:
01800.333.4444
- Argentina:
0800.333.0108
- Brazil:
0800.892.1309
- Chile:
1230.020.8949
- Peru:
0800.55076
- Puerto Rico:
1.888.793.0351
- Venezuela:
0800.100.9196

▶ Troubleshooting

Preparations

Parts and Controls

Basic Operations

Connections

Other Operations

Apps

Announcements

NetMovies

Watch movies as many times as you want and when you want. Download the NetMovies app for FREE. 1st month is FREE.

- Browse by genre, new releases or search by the content that you want to watch.
- More than 5000 titles available

Note

- This app or service may not be available in some countries/regions.
- To participate, your registration and payment data will be required. At the end of the promotional period, the subscription will be activated automatically. The subscription will be renewed automatically every month although it is cancelled in the website or through the Customer Service 5 days before its automatic renewal. A unique subscriber has access only to a unique promotion. The promotion is limited only for new subscribers. By downloading the application, you accept the terms of use which can be read in the following URL: www.netmovies.com.br/termos-uso.html

Support information

<http://atendimento.netmovies.com.br/home>

Preparations

Parts and Controls

Basic Operations

Connections

Other Operations

Apps

Announcements

Video Guide



[Guest Mode](#)

[Small Apps](#)

[Album and Movies](#)

[Registering the Remote Control](#)

[Programming Operations in the Remote Control \(Macro Function\)](#)

[Using "Small Apps"](#)

[Remote-control](#)

[Related Topic](#)

[Sharing WALKMAN](#)

[the Tablet Device with Family or Friends \(Guest Mode\)](#)

Open the help for the app

[WALKMAN](#)

[Album](#)

[Movies](#)

[▶ Troubleshooting](#)[Preparations](#)[Parts and Controls](#)[Basic Operations](#)[Connections](#)[Other Operations](#)[Apps](#)[Announcements](#)

Video Guide

[Guest Mode](#)[Small Apps](#)[Album and Movies](#)[Registering the Remote Control](#)[Programming Operations in the Remote Control \(Macro Function\)](#)[Using "Small Apps"](#)

[Open the help for the app](#)[WALKMAN](#)[Album](#)[Movies](#)

[Remote-control](#)[Related Topic](#)[Sharing WALKMAN](#)[the Tablet Device with Family or Friends \(Guest Mode\)](#)

Video Guide

[Preparations](#)

[Parts and Controls](#)

[Basic Operations](#)

[Connections](#)

[Other Operations](#)

[Apps](#)

[Announcements](#)



[Guest Mode](#)

[Small Apps](#)

[Album and Movies](#)

[Registering the Remote Control](#)

[Programming Operations in the Remote Control \(Macro Function\)](#)

[Using "Small Apps"](#)

[Remote control](#)
Related Topic

[Sharing WALKMAN](#)

[the Tablet Device with Family or Friends \(Guest Mode\)](#)

Open the help for the app

[WALKMAN](#)

[Album](#)

[Movies](#)

Preparations

Parts and Controls

Basic Operations

Connections

Other Operations

Apps

Announcements

Video Guide

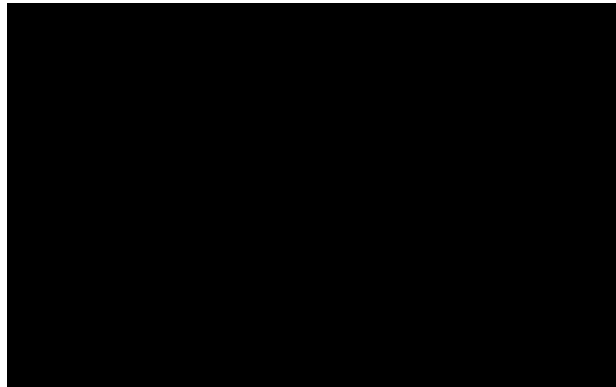

[Guest Mode](#)

[Small Apps](#)

[Album and Movies](#)

[Registering the Remote Control](#)

[Programming Operations in the Remote Control \(Macro Function\)](#)

[Using "Small Apps"](#)

[Remote-control](#)

[Related Topic](#)

[Sharing WALKMAN](#)

[the Tablet Device with Family or Friends \(Guest Mode\)](#)

[Open the help for the app](#)

[WALKMAN](#)

[Album](#)

[Movies](#)

[▶ Troubleshooting](#)[Preparations](#)[Parts and Controls](#)[Basic Operations](#)[Connections](#)[Other Operations](#)[Apps](#)[Announcements](#)

Programming Operations in the Remote Control (Macro Function)

With the macro function, you can register multiple operations of devices registered to the remote control app in succession, allowing you to perform the operations in the order registered just by tapping a button.

1. Start the Remote control app.
2. Select and tap the desired device.
3. Tap [ Macros].
4. Tap [New macro].
Register a macro in the following order.
 - Select a button.
 - Check the operation (register the timing of the operation).
 - Input a name for the macro.

Tap [OK], and then follow the on-screen instructions.

If the registration completes, a button with a macro name will appear at the bottom of the remote control screen. By tapping the button, you can run the registered macro.

[▶ Troubleshooting](#)

[Preparations](#)

[Parts and Controls](#)

[Basic Operations](#)

[Connections](#)



[Other Operations](#)

[Apps](#)

[Announcements](#)

Reverting to Factory Default (Initializing Data)

By reverting the tablet device factory default, all installed apps and settings will be deleted to give you a “clean” tablet.

1. Tap [ Apps & Widgets] - [ Settings] - [Backup & reset] - [Factory data reset].
2. Tap [Reset tablet] at the bottom of the menu on the right.
All data is initialized and the tablet device automatically restarts.

Note

- It is recommended that you make a backup copy before deleting data in the internal memory [\[Details\]](#).
- All data in the data storage area is deleted, including the Google account information, the system data and settings, and any application data you have downloaded.
- It is recommended that you make a backup copy of important data because the user data cannot be restored once deleted.

Related Topic

[Changing the Settings](#)

[▶ Troubleshooting](#)

[Preparations](#)

[Parts and Controls](#)

[Basic Operations](#)

[Connections](#)



[Other Operations](#)

[Apps](#)

[Announcements](#)

Adjusting the Screen Brightness

You can set the screen brightness manually, or set the automatic brightness setting to let the tablet device adjust the brightness automatically.

1. Tap [ Apps & Widgets] - [ Settings] - [Display] - [Brightness].
2. To adjust the brightness manually, tap or drag the brightness adjustment bar. To adjust the brightness automatically, Tap [Automatic brightness].
A check mark is put in the box for that setting.
3. Tap [OK].

Hint

- When a check mark is put in the [Automatic brightness] box, the screen may automatically become brighter but not darken. To darken the screen, adjust manually.
- You can also adjust the screen brightness on the control panel displayed by tapping the status bar.

Related Topic

[Confirming Download or Update Information on the Status Bar](#)

[▶ Troubleshooting](#)

Preparations

Parts and Controls

Basic Operations

Connections



Other Operations

Apps

Announcements

Setting the Time that Elapses Before the Screen Turns Off (Goes to Sleep)

In the default setting, the screen automatically goes to sleep if the tablet device has not been operated for a certain period. You can change the time that elapses before the screen turns off.

1. Tap [ Apps & Widgets] - [ Settings] - [Display] - [Sleep].
2. Select and tap the time that elapses before your tablet device goes to sleep.

Hint

- You can set the screen to not turn off even after the set time elapses only when charging. Tap [ Apps & Widgets] - [ Settings] - [Developer options], and then add a check mark on [Stay awake].

Related Topic

[Changing the Settings](#)

▶ [Troubleshooting](#)

Specifications

Preparations

Parts and Controls

Basic Operations

Connections

Other Operations

Apps

Announcements

Operating System	Android (TM)	
Processor	NVIDIA(R) Tegra(R) 3 mobile Processor	
	Operating frequency	Maximum 1.4 GHz (1 core operation), Maximum 1.3 GHz (MultiCore operation)
Main Memory	Memory size (installed)	1 GB
Display	Screen size/resolution	23.8 cm (9.4") WXGA (1280 × 800)
	Type	TFT Color LCD
Storage	Total capacity	SGPT121* ¹ : 16 GB SGPT122* ¹ : 32 GB SGPT123* ¹ : 64 GB SGPT131* ¹ : 16 GB SGPT132* ¹ : 32 GB SGPT133* ¹ : 64 GB
Inputs and Outputs	Multi Port	Yes
	Headphone jack	Stereo, mini jack × 1 (works as a monaural microphone jack)
Wireless LAN	IEEE 802.11a/b/g/n	
GPS Function	Yes	
Bluetooth(R) Technology	Bluetooth(R) standard Ver. 3.0	
IR Remote Control Function	Yes	
Expansion Slots	SD memory card slot × 1	
Supported SD memory card	SD, SDHC, SDHC UHS-I, SDXC, SDXC UHS-I	
Speaker	Built-in stereo speakers	
Microphone	Built-in monaural microphone	
Camera (Front)	1 M pixels	
Camera (Rear)	8 M pixels	
Supplied Accessories	USB Cable for Multi Port, AC adapter, AC power cord (mains lead)* ²	
Main Unit Dimensions	Width (mm)	239.8 mm
	Width (in)	9.45 in
	Height (H1) (mm)	8.8 mm
	Height (H1) (in)	0.35 in
	Height (H2) (mm)	11.85 mm
	Height (H2)	

	(in)	0.47 in
	Depth (D1) (mm)	174.4 mm
	Depth (D1) (in)	6.87 in
Main Unit Weight	Main Unit Weight (g)	SGPT12* ¹ : 570 g SGPT13* ¹ : 585 g
	Main Unit Weight (lb)	SGPT12* ¹ : 1.26 lb SGPT13* ¹ : 1.29 lb

*1 Some models are not available in some countries/regions.

*2 The item is not supplied in some countries/regions.

Features and specifications are subject to change without notice.

[▶ Troubleshooting](#)

[Preparations](#)

[Parts and Controls](#)

[Basic Operations](#)

[Connections](#)

[Other Operations](#)

[Apps](#)

[Announcements](#)

How to Maintain Battery Life

Using your tablet device as described below will reduce battery consumption.

- Reduce the screen brightness.
- Set a short period of inactivity before the screen turns off (switches to sleep mode) automatically.
- Turn the screen off (switch to sleep mode) when you will not be using your tablet device.
- Shut down your tablet device when you do not use it for a long time.
- Turn on airplane mode to turn off the wireless communications or Bluetooth function [\[Details\]](#).
- Disconnect USB compatible devices.
- Turn on the power save mode for the screen [\[Details\]](#).

Related Topic

[Adjusting the Screen Brightness](#)

[Turning the Screen On/Off \(Sleep Mode\)](#)

[Setting the Time that Elapses Before the Screen Turns Off \(Goes to Sleep\)](#)

[Turning On or Shutting Down Your Tablet Device](#)

[▶ Troubleshooting](#)

Preparations

Parts and Controls

Basic Operations

Connections

Other Operations

Apps

Announcements

Notes on Charging

Charging the battery

- For your safety, use only the supplied AC power cord (mains lead)* to charge the battery.
- Performance and safety are not guaranteed if you charge using anything other than the USB cable and AC adapter designed for the tablet device or a designated Sony AC adapter.
- Depending on the ambient temperature or how you use your tablet device, the battery may not charge or it may take a long time to charge the battery.
- Do not charge the battery near fire or in direct sunlight.
- The tablet device is not fully charged when shipped.
- Heat builds up in the battery while it is in use or being charged. This is normal and is not cause concern. If your tablet device or the AC adapter becomes abnormally hot, shut down your tablet device and stop using the AC adapter and tablet device.
- You may not be able to charge the battery depending on the computer used or the connector of the USB compatible device.
- You may not be able to charge the tablet device depending on the USB jack of the computer or USB device.

* You do not need an AC power cord (mains lead) in some countries.

Battery discharge

- After charging, the battery gradually loses its charge even if it is not used. If it is left unused for a long time, the battery charge may be depleted. We recommend recharging the battery before use.
- If you do not use your tablet device for an extended period of time, fully charge the battery every six months.

Battery life

- Battery life varies depending on usage, settings, and temperatures.

Battery deterioration

- Battery capacity gradually declines through repeated recharging and discharging. As a result, the battery life may become short or the battery may not perform optimally even when fully charged.

[▶ Troubleshooting](#)

[Preparations](#)

[Parts and Controls](#)

[Basic Operations](#)

[Connections](#)

[Other Operations](#)

[Apps](#)

[Announcements](#)

Notes on Using the AC Adapter

- Use the AC adapter supplied with your tablet device or a genuine Sony AC adapter. Do not use any other AC adapter as it may cause malfunctions.
- Do not connect the AC adapter to a power conversion device such as a travel power converter. Doing so may cause overheating or a malfunction.
- Do not use a damaged AC power cord (mains lead)* or USB cable for Multi Port to connect your tablet device with the AC adapter.

* You do not need an AC power cord (mains lead) in some countries.

Related Topic

[Notes on Charging](#)

[▶ Troubleshooting](#)[Preparations](#)[Parts and Controls](#)[Basic Operations](#)[Connections](#)[Other Operations](#)[Apps](#)[Announcements](#)

Adding Apps or Widgets to the Home Screen

You can flick the Home screen right/left to scroll between up to five screens. Adding app icons or widgets to your favorite location allows you to start apps easily.

1. Flick to display the Home screen on which you want to place apps icons or widgets, and then tap [ Apps & Widgets] at the top right of the screen.
2. Select the item you want to add to the Home screen from [Apps] or [Widgets].
3. Tap and hold the icon of the app or widget, then drop it when the Home screen is displayed. The icon or widget is added to the page you drop the icon or widget onto.

To delete an icon from the Home screen

Tap and hold the icon, and drag and drop it to  (Remove).

To organize icons using folders

You can use folders to organize icons on the Home screen.

1. Tap and hold an icon, then drag it on top of another icon. The two icons are then combined into a folder.
 2. Tap the combined icon folder, then tap [Unnamed Folder].
 3. Enter a new folder name, and then tap .
- The folder is shown with the new folder name.

Hint

- To add an app to a folder, tap and hold the icon, then drag and drop it into the folder.
- To remove an app from a folder, tap to open the folder, then drag the icon out of the folder. When all apps are removed from the folder, the folder is deleted automatically.

Related Topic

[Using the Home Screen](#)

[Using the Apps & Widgets List](#)

[▶ Troubleshooting](#)

[Preparations](#)

[Parts and Controls](#)

[Basic Operations](#)

[Connections](#)

[Other Operations](#)

[Apps](#)

[Announcements](#)

Turning the Screen On/Off (Sleep Mode)

In the default setting, if you do not operate the tablet device for a certain period of time, the screen turns off and becomes locked. To turn on the screen, press the power button to display the screen, and then unlock it.

When you are not using the tablet device, you can turn off the screen (switch to sleep mode) manually.

1. Press the power button.

The screen goes to sleep. The power is not completely turned off. To deactivate sleep mode and turn on the screen, press the power button again, then unlock the screen.

Hint

- You can change the time that elapses before the screen turns off (goes to sleep). You can prevent the screen from becoming locked and also change the pattern for the screen lock.

Related Topic

[Setting the Time that Elapses Before the Screen Turns Off \(Goes to Sleep\)](#)

[Configuring to Lock the Screen](#)

[▶ Troubleshooting](#)[Preparations](#)[Parts and Controls](#)[Basic Operations](#)[Connections](#)[Other Operations](#)[Apps](#)[Announcements](#)

Configuring Screen Rotation

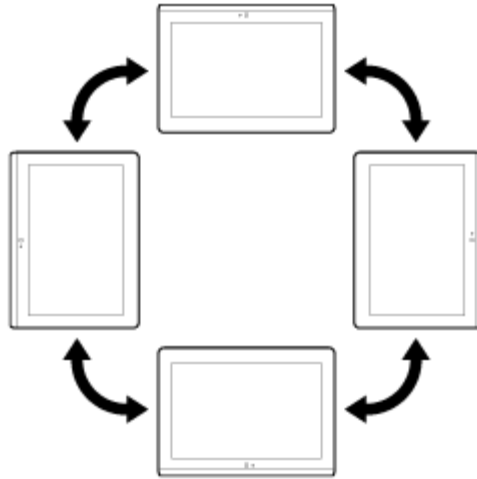

The screen rotates when you turn your tablet device sideways as shown below.



Note

- Depending on the application, the screen may rotate regardless of the direction your tablet device is held.
- Some apps may not support screen rotation. Some apps may rotate the screen in reverse.
- Screen rotation is not available when the HDMI adapter cable is attached to your tablet device.

Setting the screen to not rotate

1. Tap [ Apps & Widgets] - [ Settings] - [Display] - [Auto-rotate screen] in that order to remove the check mark and disable screen rotation.

To set the screen to rotate again

Tap [Auto-rotate screen] again to add a check mark and enable screen rotation.

You can also turn on/off the screen rotation on the control panel displayed from the status bar.

Related Topic

[Confirming Download or Update Information on the Status Bar](#)





[Changing the Settings](#)

[▶ Troubleshooting](#)[Preparations](#)[Parts and Controls](#)[Basic Operations](#)[Connections](#)[Other Operations](#)[Apps](#)[Announcements](#)

Configuring to Lock the Screen

If you set the lock function, the screen is automatically locked for security purposes when turning the screen on (deactivating sleep mode).

To configure the lock function

1. Tap [ Apps & Widgets] - [ Settings] - [Security] - [Screen lock] in that order.
 2. Tap the desired setting from the following items.
 - [None]: Lock function not used.
 - [Slide]: Default setting. Tap , then tap  to unlock.
 - [Pattern]: Trace nine pass points with a finger. If you fail to unlock five times, the entry screen for the Google account will appear. Enter your account name, and you will receive the procedure to unlock by e-mail.
 - [PIN]: Set a code of your choice consisting of four or more numbers.
 - [Passwords]: Set a password consisting of four or more numbers/letters.
- Hint
- Make sure to write down the PIN number or password you set and keep it in a safe place.
3. Follow the on-screen instructions.

Related Topic

[Changing the Settings](#)

[▶ Troubleshooting](#)

[Preparations](#)

[Parts and Controls](#)

[Basic Operations](#)

[Connections](#)

[Other Operations](#)

[Apps](#)

[Announcements](#)

Notes on the Screen

Notes on the touch screen

- Your tablet device uses a capacitive touch screen. Tap the screen directly with your fingertip. Do not scratch it or tap it with a sharp object such as a needle, pen, or fingernails. You cannot operate the touch screen with a stylus.
- If you tap the touch screen with gloved fingers, the touch screen may operate incorrectly or may not operate at all.
- Do not operate your tablet device with objects on the touch screen.
- If the touch screen is touched by anything other than your fingertip, it may not react correctly.
- Do not put the touch screen close to other electrical devices. Electrostatic discharges may cause the touch screen to malfunction.
- If there are water droplets on the touch screen, or if you touch it with wet fingertips, the touch screen may not react correctly.
- Do not put the touch screen in humid places. The touch screen may malfunction in humid conditions or when exposed to water.

Notes on the LCD screen

- Do not leave the LCD screen facing the sun. Be sure to block direct sunlight when using your tablet device near a window.
 - Using your tablet device in low temperature conditions may produce a residual image on the LCD screen. This does not indicate a malfunction. The screen will return to normal when the tablet device returns to normal temperature.
 - The LCD screen may become warm during operation. This is normal and does not indicate a malfunction.
 - The LCD screen is manufactured using high-precision technology. You may, however, see tiny black points and/or bright points (red, blue, or green) on the LCD screen. This is a normal result of the manufacturing process and does not indicate a malfunction.
 - The LCD screen is made of glass. If the glass is damaged (cracked, etc.), do not touch the touch screen or try to repair it yourself. Handle the LCD screen carefully as it is vulnerable to damage from dropping or mechanical shock. We cannot provide warranty for any damages caused by customers due to incorrect handling.
-

[▶ Troubleshooting](#)

Preparations

Parts and Controls

Basic Operations

Connections

Other Operations

Apps

Announcements

Switching to Guest Mode

1. Tap [ Guest Mode] on the Home screen.
2. Select the desired mode.
The Home screen switches to the selected Guest Mode.

To cancel Guest Mode

1. Tap [ Exit] on the Home screen.
2. If an unlock code is set, enter the unlock code, and then tap [OK].

Hint

- To change the wallpaper in Guest Mode, tap and hold the Home screen to display the wallpaper selection screen, and then select a desired wallpaper.
- To edit or delete a Guest Mode, tap and hold the thumbnail of a Guest Mode on the mode selection screen, and then tap [Edit] or [Delete].
- To add a new Guest Mode, tap [ New mode] on the mode selection screen.

Note

- The Guest Mode function is not for security purposes. It is for restraining the restricted applications from being displayed.
- The Guest Mode function does not allow each user to store and protect personal data.
- Some apps may be accessible through other apps even if you restrict them using Guest Mode.
- Make sure not to forget the unlock code and secret answer you set. If you do forget them, you will need to reset tablet device settings factory default.
 - If you forget the unlock code, entering the secret answer correctly will allow you to reset the unlock code.
- You may not be able to switch to Guest Mode if you installed home application made by a company other than Sony.
- You cannot update the system software during Guest Mode.
- Even if you switch to Guest Mode, apps used recently and notifications will remain. Apps running in the background such as apps playing music in the background also will not stop.
- Since some tablet device functions are restricted in Guest Mode, Small Apps and the Quick launcher will not be available.

Related Topic

[Sharing the Tablet Device with Family or Friends \(Guest Mode\)](#)

[▶ Troubleshooting](#)[Preparations](#)[Parts and Controls](#)[Basic Operations](#)[Connections](#)[Other Operations](#)[Apps](#)[Announcements](#)

Touch Screen Operations

Tap

Selects an icon or option.

Tapping quickly twice allows you to zoom in or out on images or other on-screen items.

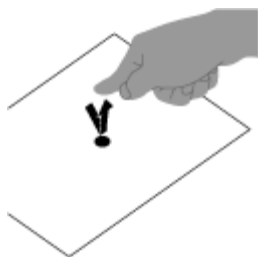

Tap & hold

Opens an option menu.

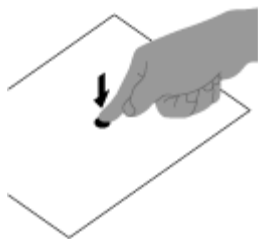

Drag

Moves an item or scrolls a page slowly.

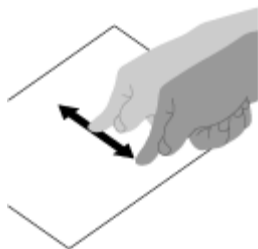

Flick

Scrolls a page quickly.

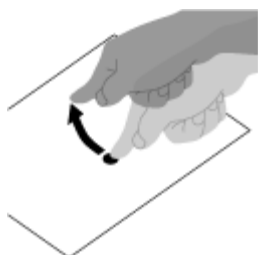

Pinch
Zooms in or out.

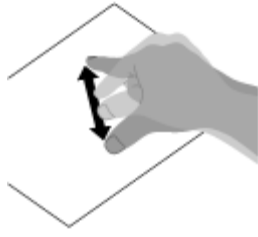

Related Topic

[Notes on the Screen](#)

▶ Troubleshooting

Preparations

Parts and Controls

Basic Operations

Connections







Other Operations

Apps

Announcements

Entering Text

You can enter text using the keyboard displayed on the screen.





Display on the screen	Description
	Switches between letters, numbers and symbols.
 *1	Enters capital letters.
 *2	Enters other symbols.
 *3	Switches the input language.
	Deletes text.
	Enters or adds linefeeds.

*1 Capital-letter entry will deactivate after you enter one letter. Tap this key every time you enter a capital letter. To input capital letters continuously (caps lock), double-tap the key. To cancel the caps lock, press this key again.





*2 This appears when you enter numbers or symbols.

*3 This appears when you have selected multiple languages to use for input. Every time you tap the key, the input mode switches between the modes you have set. Tap and hold to display the input mode switching screen.

Hint

- Pressing and holding a key with a triangle mark  on the bottom right corner allows you to enter letters or symbols, etc. related to the letter of the key.
- To enter a URL or letters, tap the area where you want to enter text to display the on-screen keyboard.
- A numerical keyboard can also be displayed. Tap [ Apps & Widgets] - [ Settings] - [ Language & input]. Then tap  next to [Standard keyboard] followed by [Number keys] to add a check mark.

To set the input language

Tap [ Apps & Widgets] - [ Settings] - [ Language & input]. Then tap  next to [Standard keyboard] followed by [Input languages], and then put a check mark on the languages to use.

To hide the on-screen keyboard

Tap  on the bottom left of the screen.

Related Topic

[Changing the Settings](#)

© 2012 Sony Corporation

[▶ Troubleshooting](#)

[Preparations](#)

[Parts and Controls](#)

[Basic Operations](#)

[Connections](#)

[Other Operations](#)

[Apps](#)

[Announcements](#)

Selecting Text

You can copy or search text from the menu that is displayed by selecting text on a website or URL.

1. Tap and hold the text.
The selected text will be highlighted.
2. Tap the desired item from the menu at the top right of the screen.

Hint

- You can change the range of text selected by dragging the cursor that appears in step 1 across the text.

To paste text

1. Tap and hold the location to paste the text, and then tap [PASTE] or [CLIPBOARD].

Hint

- Tap [CLIPBOARD] to display in a list the history of text that has been copied. Text that is frequently used can also be added to Favorites.
 - You can change the location to paste the text by dragging the cursor to a new location.
-

[▶ Troubleshooting](#)[Preparations](#)[Parts and Controls](#)[Basic Operations](#)[Connections](#)[Other Operations](#)[Apps](#)[Announcements](#)

Turning On or Shutting Down Your Tablet Device

Turning on your tablet device

1. Charge the tablet device.
2. Press and hold the power button for three seconds.
When you use the tablet device for the first time, set up the tablet device by following the on-screen instructions.

Note

- In the default setting, if you do not operate the tablet device for a certain period of time, the screen turns off and becomes locked. Press the power button again to display the screen, and then unlock it.

Shutting down your tablet device

It is recommended that you turn off (shut down) the tablet device if you will not use it for a long time.

1. Press and hold the power button until a confirmation screen appears.
2. Tap [OK].
The tablet device will automatically turn off in a few seconds.

Note

- If you turn off the tablet device while downloading or transferring data, that data may be damaged.
- If you cannot shut down your tablet device, please reset it.

Related Topic

[Parts and Controls](#)[Charging the Battery](#)[Turning the Screen On/Off \(Sleep Mode\)](#)[Setting the Time that Elapses Before the Screen Turns Off \(Goes to Sleep\)](#)[Resetting Your Tablet Device](#)

[▶ Troubleshooting](#)

[Preparations](#)

[Parts and Controls](#)

[Basic Operations](#)

[Connections](#)

[Other Operations](#)

[Apps](#)

[Announcements](#)

Resetting Your Tablet Device

If your tablet device is not performing as expected, press and hold the power button for about 10 seconds.

Note

- Resetting the tablet device does not revert the settings to factory default, but unsaved data or settings may be lost.
 - Reset the tablet device only when you cannot turn it off.
-

▶ Troubleshooting

Preparations

Parts and Controls

Basic Operations

Connections

Other Operations

Apps

Announcements

Connecting by Pressing the WPS Button on the Wi-Fi Router

If you use a Wi-Fi router compatible with WPS, press the WPS button to automatically configure the connection settings and security settings.

1. Tap [⋮ Apps & Widgets] - [⚙ Settings] - [Wi-Fi].
2. Tap the network to connect to from those on the Wi-Fi network list.
3. Tap [Show advanced options].

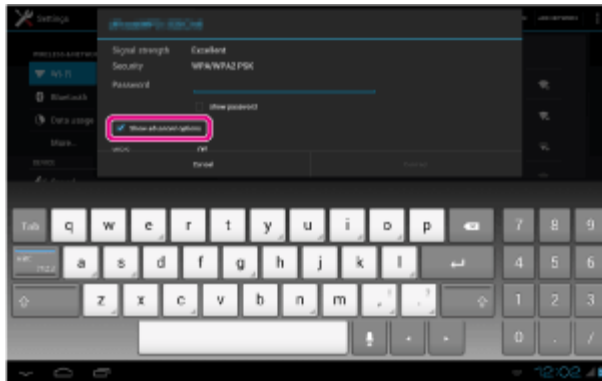

A check mark is put in the box.

4. Tap [⏴] on the bottom left of the screen.
The keyboard disappears.
5. Tap [Off] for [WPS], and then tap [Push button].

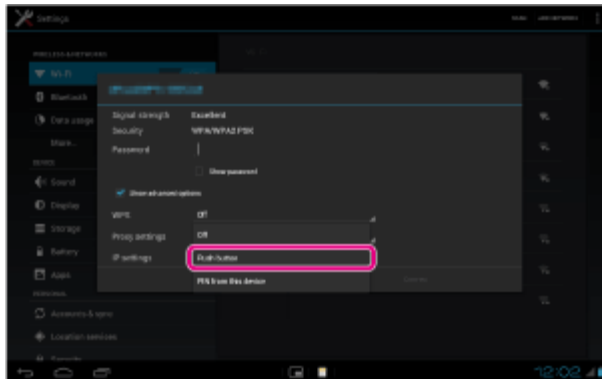

6. Press the WPS button on the Wi-Fi router (access point).
The Wi-Fi settings of the tablet device are automatically configured.



Hint

- For details on how to use the WPS button, refer to the operating instructions supplied with the Wi-Fi router.

7. Tap [Connect] on the tablet device.

When a connection is established, [Connected] appears under the SSID of the network the tablet device is connected to.

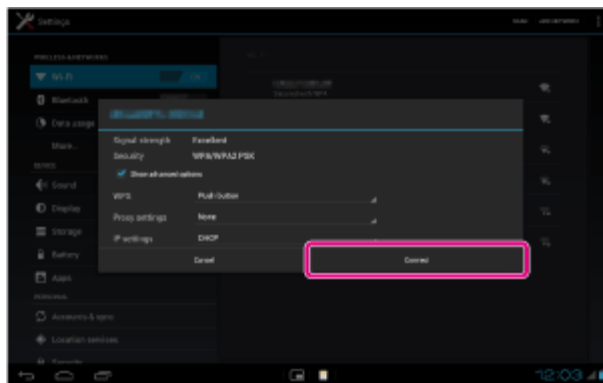

Hint

- When the tablet device connects using Wi-Fi, the Wi-Fi icon is displayed on the status bar at the bottom right of the screen.

Related Topic

[Turning On/Off the Wi-Fi Function](#)

[Connecting to Wi-Fi](#)

[Connecting from the Wi-Fi Network List](#)

[Confirming Download or Update Information on the Status Bar](#)

[Notes on Using the Wi-Fi Function](#)

[Checking the Wi-Fi Connection](#)

▶ Troubleshooting

Preparations

Parts and Controls

Basic Operations

Connections



Other Operations

Apps

Announcements

Connecting from the Wi-Fi Network List

If you are at home or using a public wireless service, connect the tablet device to an available network on the Wi-Fi network list. Some Wi-Fi routers (access points) require you to enter a password.

1. Tap [ Apps & Widgets] - [ Settings] - [Wi-Fi].
2. Tap the network to connect to from those on the Wi-Fi network list.
3. Enter the password if required.

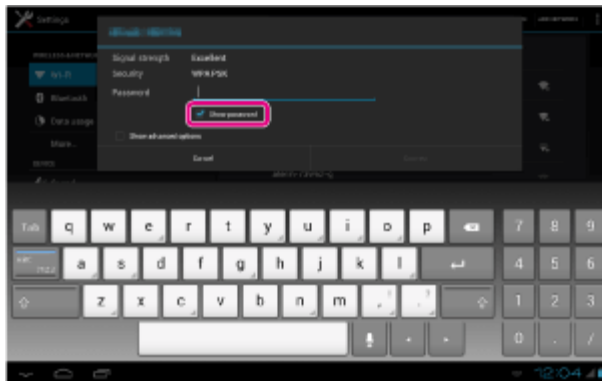

Hint

- You can check the password you entered by tapping [Show password].
- Some Wi-Fi routers call a password a “PIN CODE,” “WEP key,” “KEY,” etc.

4. Tap [Connect].

When a connection is established, [Connected] appears under the SSID of the network the tablet device is connected to.

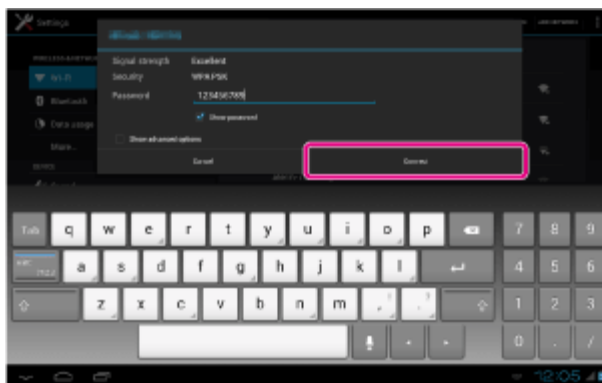

Hint

- When the tablet device connects using Wi-Fi, the Wi-Fi icon is displayed on the status bar at the bottom right of the screen.
- For proxy and IP settings, tap [Show advanced options] in step 4.

Note

- When connecting to a public wireless service, you are sometimes required to enter a user

name and password in the browser. For details, refer to the provider's website.

Related Topic

[Turning On/Off the Wi-Fi Function](#)

[Connecting to Wi-Fi](#)

[Connecting by Pressing the WPS Button on the Wi-Fi Router](#)

[Confirming Download or Update Information on the Status Bar](#)

[Notes on Using the Wi-Fi Function](#)

[Checking the Wi-Fi Connection](#)

▶ Troubleshooting

Preparations

Parts and Controls

Basic Operations

Connections

Other Operations

Apps

Announcements

Connecting to Wi-Fi

Set the Wi-Fi connection on the tablet device to connect to the Internet. Connect the tablet device to the Wi-Fi router (access point) in a manner suitable for the situation: at home or the office or using a public wireless service, etc.

1. Tap [⋮ Apps & Widgets] - [⚙ Settings] - [Wi-Fi].

Detected Wi-Fi networks are listed on the right side of the screen.



Display on the screen	Description
1 Network SSID	The name of a wireless network.
2 Security	The security protocol of the Wi-Fi router.
3 Security availability	When using a security-enabled Wi-Fi router, the lock icon will appear at the bottom right of the icon.

2. Configure the Wi-Fi setting in one of the following ways.

- Establish a connection by pressing the WPS button on the Wi-Fi router:
If you use a Wi-Fi router compatible with WPS, press the WPS button, and the connection settings and security settings will be configured automatically.
- Connect from the Wi-Fi network list:
If you are at home or using a public wireless service, connect the tablet device to a network available from the Wi-Fi network list.

Hint

- If no network is displayed in step 1, tap [SCAN] on the top right of the screen.
- If the Wi-Fi function is turned on where a Wi-Fi network connection is available, the tablet device will automatically reconnect if it had made a connection to that network previously.

Note

- Any communications and connection charges that apply for the use of the Wi-Fi router are the responsibility of the customer.
- For details on the network SSID and security format, refer to the operating instructions supplied with the Wi-Fi router.

- When connecting to a public wireless service, refer to the provider's website, etc. for instructions.

Related Topic

[Turning On/Off the Wi-Fi Function](#)

[Connecting by Pressing the WPS Button on the Wi-Fi Router](#)

[Connecting from the Wi-Fi Network List](#)

[Checking the Wi-Fi Connection](#)

[Notes on Using the Wi-Fi Function](#)

[Notes on Holding Your Tablet Device](#)

[▶ Troubleshooting](#)

Preparations

Parts and Controls

Basic Operations

Connections

Other Operations



Apps

Announcements

Turning On/Off the Wi-Fi Function

To download apps or enjoy Internet content, connect the tablet device to a Wi-Fi network (access point). To set the Wi-Fi connection, turn on the Wi-Fi function of the tablet device.

To turn on the Wi-Fi function



1. Tap [ Apps & Widgets] - [ Settings] - [Wi-Fi].
2. Set [Wi-Fi] to [ON].

Note

- The Wi-Fi antenna is built in to your tablet device. If you cover the antenna with your hands or other objects while connected to the Internet using the Wi-Fi function, the communications quality may deteriorate.

To turn off the Wi-Fi function

When you are not using Internet, you can save power by turning off the Wi-Fi function.

1. Tap [ Apps & Widgets] - [ Settings] - [Wi-Fi].
2. Set [Wi-Fi] to [OFF].

Hint

- To disconnect the Wi-Fi function temporarily in an area where Wi-Fi communications is restricted, turn on [Airplane mode] on the control panel displayed from the status bar.
- The screen of your tablet device will be off (in sleep mode) when apps are running, such as when the music player app is playing back content, but the tablet device will still be operating. You can choose whether to keep the Wi-Fi connection active or not when the screen is off (in sleep mode).
Tap [ (Option menu)] - [Advanced] - [Wi-Fi disconnect policy], and then select the desired item on the [Wi-Fi disconnect policy] screen.

Note

- Regardless of the setting in [Wi-Fi disconnect policy], the Wi-Fi connection is disconnected if no app is running during sleep mode. The Internet connection will initially be off when the screen turns on after being off (deactivating sleep mode), but the tablet device will then connect to the Internet automatically.

Related Topic[Connecting to Wi-Fi](#)

[Connecting by Pressing the WPS Button on the Wi-Fi Router](#)

[Connecting from the Wi-Fi Network List](#)

[Notes on Using the Wi-Fi Function](#)

[Confirming Download or Update Information on the Status Bar](#)

[Notes on Holding Your Tablet Device](#)

[▶ Troubleshooting](#)

[Preparations](#)

[Parts and Controls](#)

[Basic Operations](#)

[Connections](#)

[Other Operations](#)

[Apps](#)

[Announcements](#)

Checking the Free Space

When you install apps or import data from other devices, etc., you can check the free space of the tablet device.

1. Tap [ Apps & Widgets] - [ Settings] - [Storage].



Related Topic

[Backing Up Data on Your Tablet Device](#)[Importing Content from Your Computer](#)

[▶ Troubleshooting](#)[Preparations](#)[Parts and Controls](#)[Basic Operations](#)[Connections](#)[Other Operations](#)[Apps](#)[Announcements](#)

Pairing with a Bluetooth Device

To connect with a Bluetooth device, pair the tablet device and Bluetooth device. Once you pair them, your tablet device automatically connects to the Bluetooth device by just turning on both devices the next time.

1. Make sure the setting of the Bluetooth device pairing with the tablet device is in a detectable mode.
2. Tap [ Apps & Widgets] - [ Settings] - [Bluetooth].
3. Tap [SEARCH FOR DEVICES] at the top right of the screen.
The [AVAILABLE DEVICES] list is displayed.
4. Tap the name of the device you want to connect to.
5. Tap [Pair], and enter the device passkey (e.g. 0000) if necessary to connect to the Bluetooth device.

Hint

- To make the Bluetooth device settings detectable, refer to the operating instructions supplied with the Bluetooth device.
- To set the tablet device so that it can be detected by the Bluetooth device, tap the model name of your tablet device in the list displayed on the right side of the screen in step 3.
- To connect to the paired device again, tap the device name in the [Paired devices] list.

To unpair a device

You can unpair paired devices from the tablet device.

1. Tap [] of the device you want to unpair from your tablet device in the [Paired devices] list.
2. Tap [Unpair].

Related Topic

[Turning On/Off the Bluetooth Function](#)

[Notes on Using the Bluetooth Function](#)



[▶ Troubleshooting](#)[Preparations](#)[Parts and Controls](#)[Basic Operations](#)[Connections](#)[Other Operations](#)[Apps](#)[Announcements](#)

Turning On/Off the Bluetooth Function

You can establish wireless connections and communications between your tablet device and other Bluetooth devices such as a computer, mobile phone, headset, headphones or wireless keyboard. Data can be transferred between these devices without cables at a range of up to 33 feet / 10 meters in an open area.

To turn on the Bluetooth function

Turn on the Bluetooth function when pairing or connecting with a Bluetooth device.

1. Tap [ Apps & Widgets] - [ Settings] - [Bluetooth].
2. Set [Bluetooth] to [ON].

Hint



- When the Bluetooth function is turned on, the Bluetooth icon is displayed on the status bar at the bottom right of the screen.

Note

- The Bluetooth antenna is built in to your tablet device. If you cover the antenna with your hands or other objects while using the Bluetooth function, the communications quality may deteriorate.

To turn off the Bluetooth function

To reduce battery consumption, turn off the Bluetooth function when not in use.

1. Tap [ Apps & Widgets] - [ Settings] - [Bluetooth].
2. Set [Bluetooth] to [OFF].

Related Topic

[Pairing with a Bluetooth Device](#)

[Notes on Using the Bluetooth Function](#)

[Confirming Download or Update Information on the Status Bar](#)



[Notes on Holding Your Tablet Device](#)

[▶ Troubleshooting](#)[Preparations](#)[Parts and Controls](#)[Basic Operations](#)[Connections](#)[Other Operations](#)[Apps](#)[Announcements](#)



Using Location Services

You can enable apps to use location information using GPS satellites or wireless networks. That enables you to search your present location and routes to a destination.

Enabling location information

1. Tap [ Apps & Widgets] - [ Settings] - [Location services].
2. To enable reception of location information via wireless communications, tap [Google's location service].
To enable reception of location information via GPS satellites, tap [GPS satellites].
A check mark is put in the box for that setting.

Disabling location information

1. Tap [ Apps & Widgets] - [ Settings] - [Location services].
2. Tap [Google's location service] or [GPS satellites].
The check mark is removed from the box for that setting, and location information is disabled.

Hint

- The GPS (Global Positioning System) function provides location information by receiving signals from GPS satellites. You can see the location where you are with your tablet device by using an app that supports the GPS function.

Note

- The GPS antenna is built in to your tablet device. If you cover the antenna with your hands or other objects while using the GPS function, the positioning accuracy may deteriorate.

Related Topic

[Notes on GPS Function](#)[Notes on Holding Your Tablet Device](#)

[▶ Troubleshooting](#)

[Preparations](#)

[Parts and Controls](#)

[Basic Operations](#)

[Connections](#)

[Other Operations](#)

[Apps](#)

[Announcements](#)

Checking the Supplied Items

- USB Cable for Multi Port
 - AC adapter
 - AC power cord (mains lead) (not supplied in some countries/regions)
 - Quick Setup Guide
 - Important Information
-

▶ [Troubleshooting](#)

Preparations

Parts and Controls

Basic Operations

Connections

Other Operations

Apps

Announcements

Notes on Holding Your Tablet Device

- Some apps may not support screen rotation. Some apps may rotate the screen in reverse.
- Be careful not to hold or cover the antennas shown in the figure below while using the Wi-Fi, Bluetooth, GPS, or mobile communications functions.

SGPT12

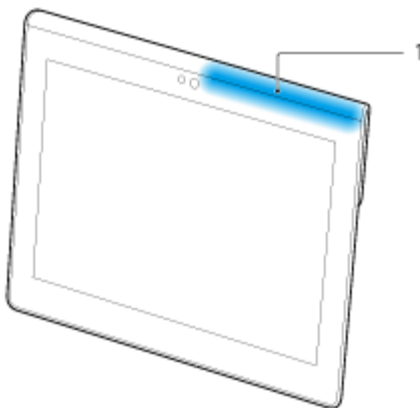

1. Wi-Fi / Bluetooth / GPS

SGPT13

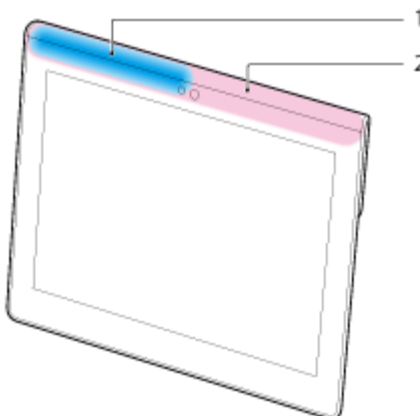

1. Wi-Fi / Bluetooth / GPS
2. Mobile communications

- Do not put your fingernails in the accessory attachment slot or in the groove (shown below) when holding the tablet device.

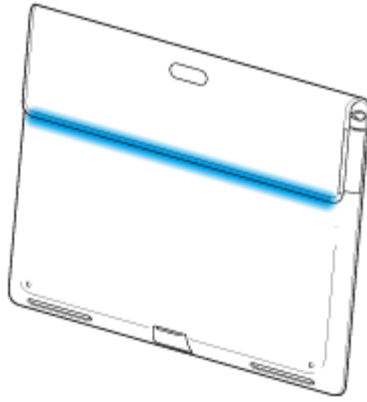

Note

- Some models are not available in some countries/regions.
-

[▶ Troubleshooting](#)[Preparations](#)[Parts and Controls](#)[Basic Operations](#)[Connections](#)[Other Operations](#)[Apps](#)[Announcements](#)

Notes on Using the Wi-Fi Function

- Use of Wi-Fi devices may be restricted by local regulations in some countries or regions.
- Wi-Fi devices work on the 2.4 GHz band, which is used by a variety of devices. Wi-Fi devices therefore use technology to minimize radio interference from other devices that use the same band. However, radio interference may still cause slower data transfer speeds, reduce communications range or cause communications failure.
- If both the Bluetooth function and the 2.4 GHz Wi-Fi function of your tablet device are enabled, interference may occur and cause slower data transfer speeds or other problems.
- To communicate via Wi-Fi while traveling, you may need to contract with a Wi-Fi connection service provider.
- Data transfer speed and communications range may vary depending on the following conditions:
 - Distance between devices
 - Presence of obstacles between devices
 - Device configuration
 - Signal conditions
 - Surrounding environment (wall material, etc.)
 - Software in use
- Communications failure may occur in some signal conditions.
- The data transfer rate noted in the specifications is the theoretical maximum, and it may not reflect actual data transfer rate.
- Actual data transfer speed may not be as fast as the speed displayed on your tablet device.
- Communications is not available between the 2.4 GHz and 5 GHz Wi-Fi frequency bands.
- The data transfer rate for IEEE 802.11g and IEEE 802.11n (2.4 GHz) devices may be affected by interference when those protocols are used with IEEE 802.11b products. Also, products using IEEE 802.11g and IEEE 802.11n automatically lower the transfer rate to maintain compatibility with IEEE 802.11b products.
- When the data transfer speed is not as fast as expected, changing the wireless channel on the Wi-Fi router may increase the speed.
- Only use Wi-Fi indoors when using it with IEEE 802.11a/n (5 GHz).

Related Topic

[Specifications](#)

[▶ Troubleshooting](#)

[Preparations](#)

[Parts and Controls](#)

[Basic Operations](#)



[Connections](#)

[Other Operations](#)

[Apps](#)

[Announcements](#)

Disabling Mobile Communications (SGPT13)

1. Tap [ Apps & Widgets] - [ Settings] - [More...] - [Mobile networks] - [Data enabled].
The check mark is removed from the box for that setting.

Hint

- To temporarily turn off functions that use mobile networks in an area where wireless communications is restricted, turn on [Airplane mode] on the control panel displayed from the status bar.

Related Topic[Enabling Mobile Communications \(SGPT13\)](#)[Confirming Download or Update Information on the Status Bar](#)

▶ [Troubleshooting](#)

[Preparations](#)

[Parts and Controls](#)

[Basic Operations](#)

[Connections](#)

[Other Operations](#)

[Apps](#)

[Announcements](#)

Enabling Mobile Communications (SGPT13)

1. Tap [ Apps & Widgets] - [ Settings] - [More...] - [Mobile networks] - [Data enabled].

A check mark is put in the box for that setting.

Note

- Make sure a SIM card is inserted before using the mobile communications function.
- The mobile communications antenna is built in to your tablet device. If you cover the antenna with your hands or other objects while connected to the Internet using the mobile communications function, the communications quality may deteriorate.
- When you are outside a mobile communications area, you cannot connect to the Internet using the mobile communications function. Check the communications conditions, and move to an area with mobile communications reception.
- When you are outside a mobile communications area with the mobile communications function activated, battery consumption is greater than when you are inside a mobile communications area.

Related Topic

[Inserting/Removing a SIM Card \(SGPT13\)](#)

[Setting Up an Access Point \(SGPT13\)](#)

[Disabling Mobile Communications \(SGPT13\)](#)

[Notes on the SIM Card \(SGPT13\)](#)

[Notes on Holding Your Tablet Device](#)

▶ Troubleshooting

Preparations

Parts and Controls

Basic Operations

Connections

Other Operations

Apps

Announcements

Inserting/Removing a SIM Card (SGPT13)

To insert a SIM card

1. Make sure all the cables are unplugged from your tablet device, and then shut down the tablet device.
2. Open the cover of the SIM card slot.

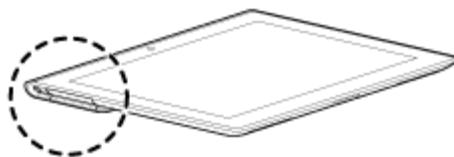

3. Insert a pin or small paper clip (not supplied) into the SIM card eject hole.

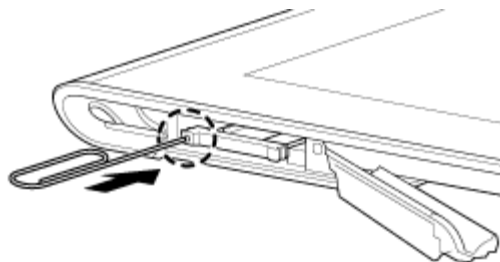

Hint

- When you purchase your tablet device, a label is attached to the SIM tray. Pull the label to pull out the SIM tray. Remove the label when you insert the SIM card.

4. Eject the SIM tray.

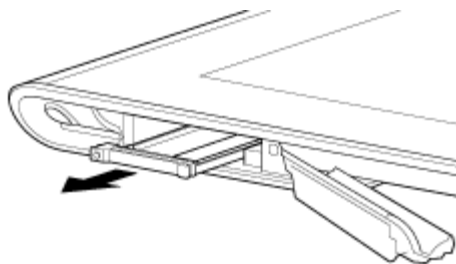

Note

- Make sure to handle the SIM tray gently.

5. Place a SIM card on the SIM tray so that the cutout of the SIM card fits that of the SIM tray.

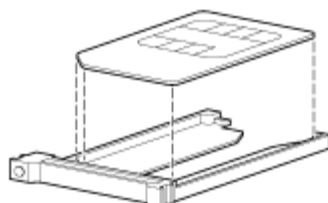

Note

- Make sure there are no protrusions on the cutting surface after detaching the SIM card from its plastic package. Protrusions will prevent the SIM card from fitting in the SIM tray.

6. Insert the SIM tray.

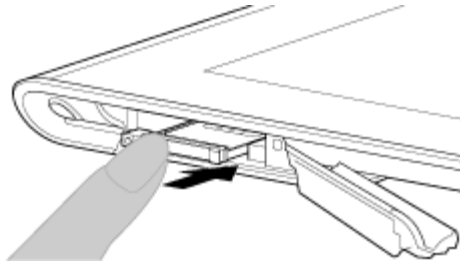

Note

- Make sure not to insert the SIM tray in the reverse direction.
- Insert the SIM tray correctly into the SIM card slot (A, lower slot). Make sure not to insert the SIM tray into the SD memory card slot (B, upper slot).

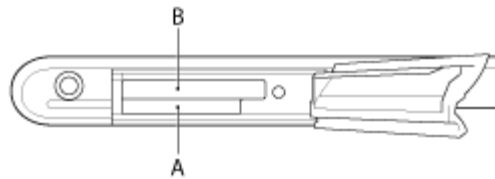

7. Insert part A in the direction indicated by the arrow as shown in the following illustration.

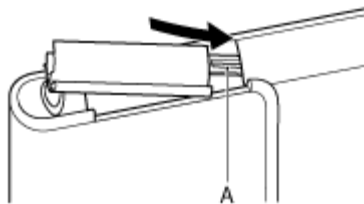

8. Close the cover of the SIM card slot.

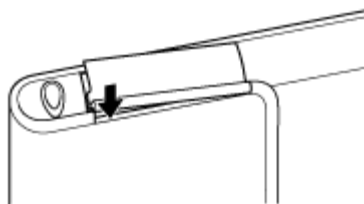

9. Make sure the cover closes securely with no gaps.

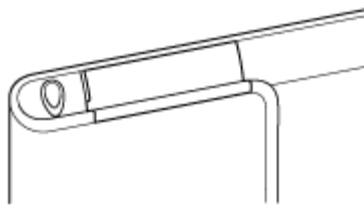

Note

- It may be hard to close the cover of the SIM card slot because the projection on the rear side of the cover and the SD memory card can interfere with closing. Make sure the cover closes securely with no gaps.

To remove a SIM card

1. Follow the procedures up to step 4 of “To insert a SIM card,” then remove the SIM card from the tray.

Related Topic

[Enabling Mobile Communications \(SGPT13\)](#)

[Turning On or Shutting Down Your Tablet Device](#)

[Setting Up an Access Point \(SGPT13\)](#)

[Notes on the SIM Card \(SGPT13\)](#)

[▶ Troubleshooting](#)

[Preparations](#)

[Parts and Controls](#)

[Basic Operations](#)

[Connections](#)

[Other Operations](#)

[Apps](#)

[Announcements](#)

Setting Up an Access Point (SGPT13)

To confirm the current access point

1. Tap [⋮ Apps & Widgets] - [⚙ Settings] - [More...] - [Mobile networks] - [Access Point Names].

To add an access point

1. Tap [⋮ Apps & Widgets] - [⚙ Settings] - [More...] - [Mobile networks] - [Access Point Names].
2. Tap [⋮] (Option menu) - [New APN].
3. Tap [Name], and enter the profile name of the network you want to add.
4. Tap [APN], and enter an access point name.
5. Enter all the items required by the carrier.
6. Tap [Save].
The settings are saved.

To reset the access point

1. Tap [⋮ Apps & Widgets] - [⚙ Settings] - [More...] - [Mobile networks] - [Access Point Names].
2. Tap [⋮] (Option menu) - [Reset to default].

Related Topic

[Enabling Mobile Communications \(SGPT13\)](#)[Inserting/Removing a SIM Card \(SGPT13\)](#)

[▶ Troubleshooting](#)

[Preparations](#)

[Parts and Controls](#)

[Basic Operations](#)

[Connections](#)

[Other Operations](#)

[Apps](#)

[Announcements](#)

Notes on the SIM Card (SGPT13)

- Make sure the power of your tablet device is turned off before inserting or removing the SIM card.
 - Do not press the SIM card more than necessary when inserting or removing a SIM card.
 - If you remove the SIM card right after using your tablet device, the SIM card may be warm. This is normal and does not indicate a malfunction.
 - Avoid exposing the SIM card to very cold, hot, or humid places.
 - Do not touch the contacts or terminals with your fingers or metal objects. If dirty, wipe the card with a soft cloth and keep it clean.
 - Do not drop, press, or bend the SIM card.
 - Do not insert the SIM card with labels or stickers in place.
 - Xperia(TM) Tablet S supports mini-SIM cards (2FF). Using a card other than a mini-SIM card (2FF) or one with an adapter may damage the SIM card slot.
-

[▶ Troubleshooting](#)

[Preparations](#)

[Parts and Controls](#)

[Basic Operations](#)

[Connections](#)

[Other Operations](#)

[Apps](#)

[Announcements](#)

Accessing Sites from Bookmarks/Access History

You can access a website from a registered bookmark or the access history.

1. Tap .
2. Tap [BOOKMARKS] or [HISTORY].
 - [BOOKMARKS]: Displays the list of registered bookmarks.
 - [HISTORY]: Displays the list of websites you accessed previously.
3. Tap the item you want to display.

To delete the access history

Tap  while the access history is up.

[▶ Troubleshooting](#)

[Preparations](#)

[Parts and Controls](#)

[Basic Operations](#)

[Connections](#)

[Other Operations](#)

[Apps](#)

[Announcements](#)

Adding Bookmarks

The bookmark function allows you to record addresses (URLs) of websites you visit frequently, allowing you to access those sites quickly. You can also add shortcuts to these URLs on the Home screen.

To add a bookmark for an address (URL)

Tap  at the right of the address bar to check the detailed information, and then tap [OK].

To make a shortcut on the Home screen for an address (URL)

Tap  at the right of the address bar, select [ Home screen] as the destination, and then tap [OK].

To access a website from its bookmark

Tap  to bring up the list of registered bookmarks. Tap the desired website from the list.

Related Topic

[Accessing Sites from Bookmarks/Access History](#)

▶ [Troubleshooting](#)

Preparations

Parts and Controls

Basic Operations

Connections

Other Operations

Apps

Announcements

Parts and Controls

Front

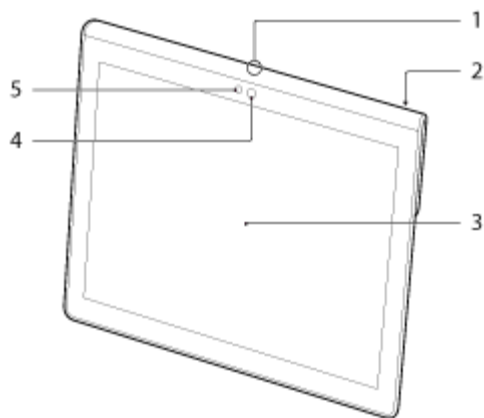

1. Microphone
2. IR data port
3. Touch screen
4. Front camera lens
5. Ambient light sensor

Side

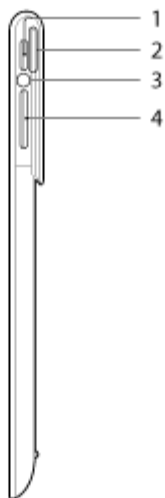

1.  (Power) button
2. Notification LED

3. Charge indicator

4. VOL + / - (Volume) button

The VOL + button has a tactile dot to help you find the button easily.

Rear

SGPT12

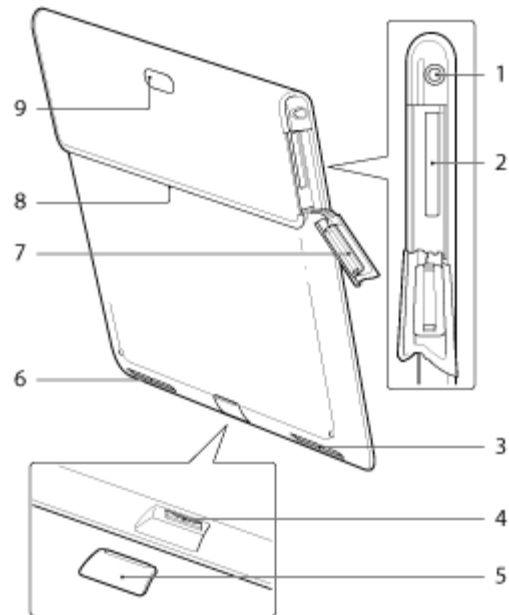

1. 🎧 (Headset) jack

2. SD memory card slot

3. Built-in speaker (L)

4. Multi Port

5. Multi Port cover

6. Built-in speaker (R)

7. SD Memory card slot cover

8. Accessory attachment slot

9. Rear camera lens

SGPT13

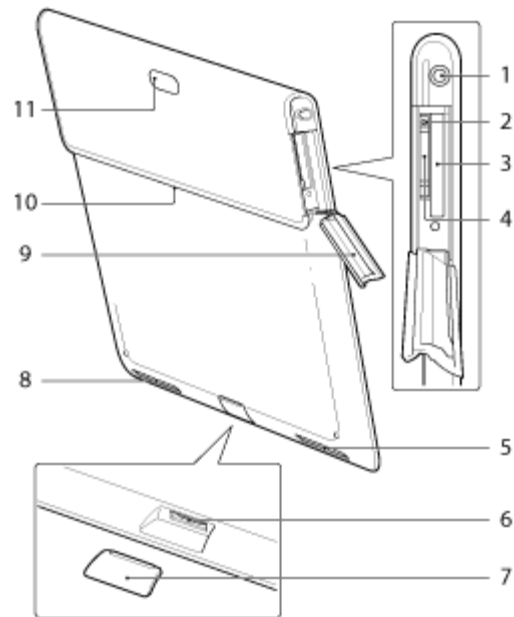

1. 🎧 (Headset) jack
2. SIM card eject hole
3. SD memory card slot
4. SIM card slot
5. Built-in speaker (L)
6. Multi Port
7. Multi Port cover
8. Built-in speaker (R)
9. SD Memory card slot cover
10. Accessory attachment slot
11. Rear camera lens

Some models are not available in some countries/regions.

Related Topic

[Turning On or Shutting Down Your Tablet Device](#)

[Charging the Battery](#)

[Using the Home Screen](#)

[▶ Troubleshooting](#)

Preparations

Parts and Controls

Basic Operations

Connections

Other Operations

Apps

Announcements

Notes on Use

Cover

- Close the SD memory card slot cover securely.
- Do not open/close the Multi Port cover when using the tablet device outdoors or with wet, sweaty, or sand-covered hands. Getting water or sand inside the tablet device may cause malfunctions.
- Keep the Multi Port cover out of reach of small children to prevent it from being accidentally swallowed.
- The tablet device has a splash-proof feature*¹ equivalent to IPX4 (Protected against water splashing from any direction) of IEC 60529 (Degrees of protection provided by enclosures (IP code)) but is not completely waterproof. Do not use the tablet device in water or splash a lot of water on the tablet device. If used improperly, water may get inside the tablet device and cause fire, electric shock or malfunctions [\[Details\]](#).

*1 The splash-proof feature applies to pure water and tap water. The splash-proof feature works with your tablet device on a stand, such as Sony Tablet Stand (SGPDS4, sold separately, not available in some countries/regions) and with all covers closed completely.

Caring for your tablet device

- Clean the cabinet with a soft, dry cloth or one slightly moistened with a mild detergent solution. Do not use a detergent solution for cleaning the touch screen. Do not use an abrasive pad, scouring powder, or solvent such as alcohol or benzene, as these may damage the finish of your tablet device.
- If your tablet device is exposed to moisture such as rain or extreme humidity, wipe your tablet device with a soft dry cloth. Do not dry with an oven or dryer.
- Clean the lens of the built-in camera with a blower brush or a soft brush. If the lens is extremely dirty, wipe it off with a soft dry cloth. Do not rub the lens, as it is sensitive to pressure.

Usage environment

- Do not use or leave the tablet device where the temperature is extremely high (about 35 °C (95 °F) or higher) or low (about 5 °C (41 °F) or lower), or in a humid place such as a bathroom or sauna. If you use or leave the tablet device out of the range stated, the tablet device may stop automatically to protect the internal circuitry.
- Do not take your tablet device directly from a cold place to a warm place. A sudden change of the temperature causes moisture condensation, and moisture may condense inside the tablet device. If this happens, leave the tablet device at room temperature until it dries before using.

Sample data

- Sample data is installed on your tablet device at the factory for a trial of music, videos, photos, and books. Once you delete the sample data, you cannot restore it. Please note that Sony will

not provide replacement sample data if deleted.

© 2012 Sony Corporation

▶ [Troubleshooting](#)[Preparations](#)[Parts and Controls](#)[Basic Operations](#)[Connections](#)[Other Operations](#)[Apps](#)[Announcements](#)

Splash-proof Performance

Splash-proof feature of the tablet device

The tablet device has a splash-proof feature*¹ equivalent to IPX4 (Protected against water splashing from any direction) of IEC 60529 (Degrees of protection provided by enclosures (IP code)) but is not completely waterproof. Do not use the tablet device in water or splash a lot of water on the tablet device.

If used improperly, water may get inside the tablet device and cause fire, electric shock or malfunction.

Please understand the following cautions before using your tablet device.

*1 The splash-proof feature works with your tablet device on a stand, such as Sony Tablet Stand (SGPDS4, sold separately, not available in some countries/regions) and with all covers closed completely.

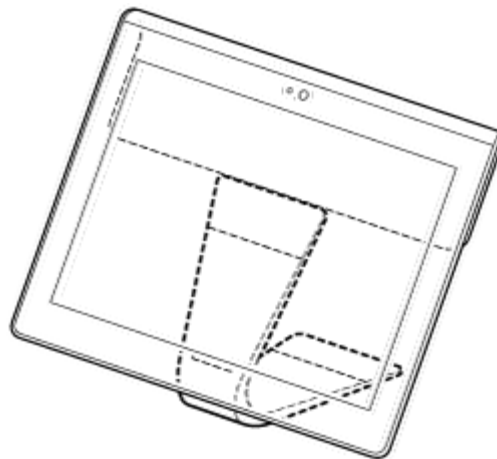

Applicable liquids

- Protected against pure water and tap water
- Not protected against liquids other than those specified above (soap water, water containing detergents or bath salt, shampoo, hot spring water, pool water, seawater, etc.)

Performance of the splash-proof feature is based on measurements performed by Sony under the conditions stated above.

Please note that malfunctions caused by water exposure due to misuse are not covered under warranty.

Notes on charging

The supplied AC adapter and USB cable for Multi Port (SGPUC2) are not equipped with a splash-proof feature.

Make sure not to splash water on the AC adapter.

Do not use the AC adapter with wet hands or when the tablet device is wet. Doing so may cause danger of electric shock.

Please note the following cautions when charging the tablet device.

- Make sure the place you use the AC adapter is not wet.
- Make sure the tablet device is not wet before charging. If the tablet device becomes damp with water droplets, wipe the droplets completely with a dry cloth, and then leave the tablet device at room temperature until it is dry before charging.

Cautions when using the tablet device in the kitchen or other places with risk of splashing

Do not use the tablet device while connected to the AC adapter.

Make sure to use the tablet device with power from the internal battery pack.

Handling the AC adapter with wet hands or when the tablet is wet may cause danger of electric shock.

The splash-proof feature is only effective with all covers closed completely.

When closing covers, make sure small foreign objects (such as hair and sand) are not trapped in the covers. If water gets in the  (headset) jack, wipe off the water and leave the tablet device in a well-ventilated shady place until it is completely dry before attempting to use.

Do not use or leave the tablet device in a humid place such as a bathroom or sauna.

Do not use the tablet device with the headphones or headset connected.

Do not use the tablet device in water or splash a lot of water on it.

If the tablet device becomes wet, wipe it dry with a soft dry cloth, etc.

Do not let liquid such as soap water, shampoo, water containing detergents or bath salt, hot spring water, pool water or seawater get on or in your tablet device. Do not let foreign objects such as sand or mud get on the tablet device.

If something accidentally gets on the tablet device, wipe your tablet device with a soft dry cloth. Do not use detergents, chemicals or moist towelettes, etc. Do not dry the tablet device by blowing hot air using a hair dryer, putting the tablet device in the oven, etc.

Do not use the tablet device where water may splash on the tablet device strongly.

The tablet device is not resistant to water pressure. Exposing the tablet device to high water pressure such as that from a tap or shower may cause malfunctions.

Do not expose the tablet device to heat such as that from a hot shower, hair dryer, or a hot place such as near a stove.

The tablet device is not heat-resistant. Use the tablet device at temperature in the range of 5 °C (41 °F) to 35 °C (95 °F).

Note

- The Multi Port cover is necessary to make the use of the splash-proof feature. Keep the Multi Port cover in a safe place.
- Use the tablet device with the Multi Port cover and SD memory card slot cover attached. Otherwise, you will not be able to make the use of the splash-proof feature of the tablet device.

Related Topic

[Parts and Controls](#)

▶ Troubleshooting

Preparations

Parts and Controls

Basic Operations

Connections

Other Operations

Apps

Announcements

Supported Formats

Playable formats vary depending on the app or content used.

Note

- Some files may not be playable on your tablet device.

Videos

Format/ Codec	Profile	Maximum resolution	Maximum bit rate (Mbps)	 Gallery
				Extension
H.263	Profile0	704 × 576 (4CIF)	4	.mp4 .3gp
H.264 / AVC	Baseline Profile / Main Profile / High Profile	1920 × 1080	40	.mp4 .m4v .3gp
MPEG-4	Simple Profile / Advanced Simple Profile	1920 × 1080	10	.mp4 .3gp
WMV	Simple Profile / Main Profile	1920 × 1080	10	-

Music

Format/ Codec	Sampling rate (kHz)	Maximum bit rate (kbps)	 Play Music
			Extension
AAC	Up to 48	320	.m4a .mp4 .3gp
MP3	Up to 48	320	.mp3
WAV	44.1	-	.wav
WMA	44.1	320	.wma
WMA Pro	44.1	192	.wma
FLAC	Up to 48	-	.flac
MIDI	-	-	.mid .xmf
Vorbis	Up to 48	256	.ogg

Photos

Format/ Codec	Maximum resolution (pixels)	 Gallery
		Extension
JPEG	6048 × 4032	.jpg
GIF	2000 × 2000	.gif
PNG	2000 × 2000	.png
BMP	2000 × 2000	.bmp
WBMP	2000 × 2000	.wbmp
WEBP	2000 × 2000	.webp

Related Topic

[Importing Content from Your Computer](#)

[Connecting a USB Compatible Device](#)

[Importing/Exporting Contents from an SD Memory Card](#)

[▶ Troubleshooting](#)[Preparations](#)[Parts and Controls](#)[Basic Operations](#)[Connections](#)[Other Operations](#)[Apps](#)[Announcements](#)

Connecting a USB Compatible Device

Your tablet device can be connected to a USB device by using the Multi Port of the tablet device.

1. Turn over your tablet device, and then remove the cover for Multi Port.
2. Connect a USB device to your tablet device using a designated USB host adapter cable (SGPUC3, sold separately) and a commercially available USB cable.

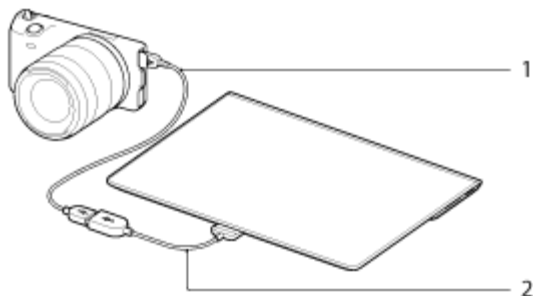

1. Commercially available USB cable
2. Designated USB host adapter cable (SGPUC3, sold separately)

Hint

- Your tablet device supplies up to 500 mA of power to a connected USB device.

Note

- Do not turn off your tablet device while reading and writing data via USB.
- Do not disconnect the cable while writing and reading data. Doing so may result in loss of that data.

Related Topic

[Connecting to a Computer](#)[Connecting to an HDMI Compatible Device](#)[Supported Formats](#)

[▶ Troubleshooting](#)[Preparations](#)[Parts and Controls](#)[Basic Operations](#)[Connections](#)[Other Operations](#)[Apps](#)[Announcements](#)

Connecting to a Computer

You can connect your tablet device to a computer by using the Multi Port of the tablet device.

1. Turn over your tablet device, and then remove the cover for Multi Port.
2. Connect your tablet device to a computer using the supplied USB cable for Multi Port (SGPUC2).

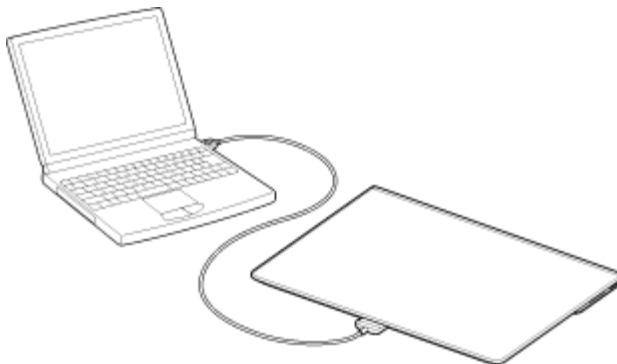
**Note**

- Do not turn off your tablet device while reading and writing data.
- Your tablet device does not support charging the battery via USB connection from a computer or a commercially available charger not designated by Sony.
- Do not disconnect the USB cable for Multi Port while writing and reading data. Doing so may result in loss of that data.

Related Topic

[Supported Formats](#)[Connecting a USB Compatible Device](#)[Connecting to an HDMI Compatible Device](#)[Importing Content from Your Computer](#)

[▶ Troubleshooting](#)

[Preparations](#)

[Parts and Controls](#)

[Basic Operations](#)

[Connections](#)

[Other Operations](#)

[Apps](#)

[Announcements](#)

Importing Content from Your Computer

If you connect a computer to your tablet device using the supplied USB cable for Multi Port (SGPUC2), you can copy data on the computer to your tablet device. The copied data can then be played back on your tablet device.

1. Connect the tablet device to your computer using the supplied USB cable for Multi Port (SGPUC2).
2. On the computer, open a folder that includes the file you want to export to the tablet device.
3. Click the [Start] button on your computer.
4. Click [Computer].
5. Double-click the model name of your tablet device.
6. Double-click the destination to save the data.
7. Drag and drop the file you want to copy onto this screen.

Note

- The menu name displayed in the procedure above varies depending on your computer operating system, computer environment or the Android operating system of the tablet device.
- Do not turn off the tablet device or remove the USB cable for Multi Port (SGPUC2) while copying data. That may cause the data to be damaged.
- Your tablet device does not support charging the battery via USB connection from a computer or a commercially available charger not designated by Sony.
- Only copied data in supported file formats can be played back on your tablet device.
- Check the free space of your tablet device when you import data from the computer.

Related Topic

[Connecting to a Computer](#)

[Checking the Free Space](#)

[Supported Formats](#)

▶ [Troubleshooting](#)

Preparations

Parts and Controls

Basic Operations

Connections

Other Operations

Apps

Announcements

Inserting/Removing an SD Memory Card

Your tablet device is equipped with an SD memory card slot. You can use this slot to transfer data to and from digital cameras, camcorders, music players, and other audio/video devices.

To insert an SD memory card

1. Open the cover of the SD memory card slot.
2. Locate the SD memory card slot.
3. Hold the SD memory card with the contacts facing down and the arrow pointing toward the SD memory card slot.

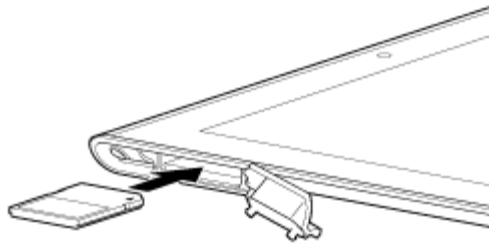

Note

- Be careful not to insert an SD memory card at the wrong orientation. If you force it into the slot upside down, the slot may be damaged. For details, refer to the manual of the SD memory card.

4. Carefully slide the SD memory card into the slot until it clicks into place.
5. Insert part A in the direction indicated by the arrow as shown in the following illustration.

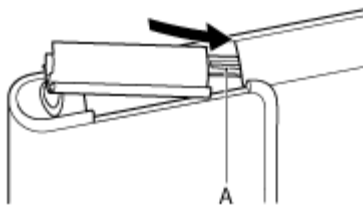

6. Close the cover of the SD memory card slot.

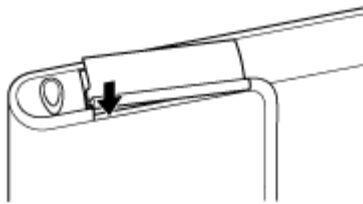

7. Make sure the cover closes securely with no gaps.

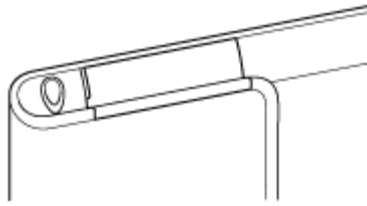

Note

- It may be hard to close the cover of the SD memory card slot because the projection on the rear side of the cover and the SD memory card can interfere with closing. Make sure the cover closes securely with no gaps.

To remove an SD memory card

1. Make sure files are not being transferred.
2. Locate the SD memory card slot.
3. Push in the SD memory card all the way and release.
The SD memory card is ejected.
4. Hold the SD memory card, and pull it out of the slot.

Related Topic

[Compatibility of SD Memory Cards](#)

[Notes on SD Memory Cards](#)

[Importing/Exporting Contents from an SD Memory Card](#)

[▶ Troubleshooting](#)

[Preparations](#)

[Parts and Controls](#)

[Basic Operations](#)



[Connections](#)

[Other Operations](#)

[Apps](#)

[Announcements](#)

Sharing Photos/Videos

1. Tap and hold the album or thumbnail for photos you want to share, and then tap  or tap  on the playback screen.
2. Tap on the name of the service you want to use to share photos or videos.
3. Post the photos or videos by following the on-screen instructions.

Hint

- You can select multiple photos or videos by tapping and holding thumbnails in succession.

Related Topic[Editing Photos](#)

[▶ Troubleshooting](#)

[Preparations](#)

[Parts and Controls](#)

[Basic Operations](#)

[Connections](#)

[Other Operations](#)

[Apps](#)

[Announcements](#)

Using “Media Go”

Media Go is computer software that supports content management and transfers content between your tablet device and computer. By installing Media Go in your computer, you can transfer music, photos, and videos to your tablet device.

Note

- For details on how to use Media Go, refer to the help in the main menu of Media Go.

Installing Media Go on your computer

1. Access <http://www.sony.com/mediago/Tablet> from your computer and download Media Go.
2. Double-click the downloaded file.
3. Install Media Go by following the instructions on the screen.
If you are prompted to install additional software components during installation, download and install them as instructed.

Transferring content to your tablet device using Media Go

1. Connect your computer to your tablet device with the supplied USB cable for Multi Port.
2. Start Media Go by selecting it from the start menu of your computer.
You can now transfer content between your tablet device and computer.

Note

- If [the model name of your tablet device] is not displayed on the left of the Media Go screen, this means that your tablet device is not recognized by the computer. Check whether or not the device driver is installed correctly.
- For details on using Media Go on a computer, refer to <http://www.sony.com/mediago/Tablet>.

Related Topic

[Connecting to a Computer](#)

▶ [Troubleshooting](#)

Preparations

Parts and Controls

Basic Operations

Connections

Other Operations

Apps

Announcements

Editing Photos

1. On the playback screen, tap  (Option menu) - [Edit].
2. Tap [Photo editor].
3. Tap the edit icon at the bottom of the screen.
You can add various effects to your photos.

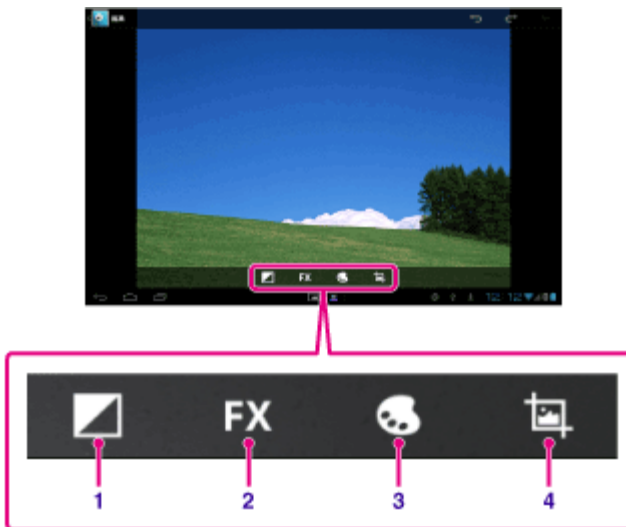

Display on the screen		Description
1	Brightness	Sets photo brightness settings such as for highlights.
2	Effects	Sets photo effect settings such as for posterization.
3	Color	Sets color settings such as for saturation.
4	Edit	Sets photo edits such as cropping.

4. When you are finished editing, tap [SAVE].

Related Topic

[Sharing Photos/Videos](#)

[▶ Troubleshooting](#)

[Preparations](#)

[Parts and Controls](#)

[Basic Operations](#)

[Connections](#)

[Other Operations](#)

[Apps](#)

[Announcements](#)

Notes on Recorded Photos/Movies

Copyright and portrait rights

The images and sounds you record on your tablet device may be copyrighted. Unauthorized use of such materials other than for personal use may violate copyright laws. Using or modifying images or names of other people without their permission may violate portrait rights. You should thus take into account copyright and portrait rights when putting recorded images on Internet websites. Some performances, shows and exhibits may restrict recording, even if it is for personal use. Unauthorized recording of such materials may be contrary to copyright laws.

[▶ Troubleshooting](#)

[Preparations](#)

[Parts and Controls](#)

[Basic Operations](#)

[Connections](#)

[Other Operations](#)

[Apps](#)

[Announcements](#)

Using Your Tablet Device as a Remote Control

You can switch between two types of remote controls on the remote control screen.

- “Full” remote control
You can operate the remote control function by tapping buttons, just like with an ordinary IR remote control.
- “Gesture” remote control
This gives a new feel to remote control operations. The remote control function reacts when the tablet device senses movement of your fingers such as tapping and flicking on the touch screen, no matter where on the screen you touch. That way, you can operate the remote control instinctively, without looking at the screen of your tablet device.

Related Topic

[Registering the Remote Control](#)

[Using “MediaRemote”](#)

[▶ Troubleshooting](#)

[Preparations](#)

[Parts and Controls](#)

[Basic Operations](#)



[Connections](#)

[Other Operations](#)



[Apps](#)

[Announcements](#)

Composing/Sending an E-mail

1. On the e-mail list screen, tap  at the top right of the screen.
The e-mail composing screen is displayed.
2. Tap [To], and then input the recipient's e-mail address.
3. Input the subject at [Subject].
4. Input the message at [Compose email].
5. Tap [ SEND].
Your e-mail is sent.

Hint

- Tapping  in step 2 allows you to get the address from the [ People] app.
- Tapping  in step 3 allows you to attach a file to your e-mail.
- Tapping [Save draft] while composing allows you to save the draft.

Related Topic[Receiving/Deleting E-mails](#)

[▶ Troubleshooting](#)

[Preparations](#)

[Parts and Controls](#)

[Basic Operations](#)

[Connections](#)

[Other Operations](#)

[Apps](#)

[Announcements](#)

Receiving/Deleting E-mails

1. On the e-mail list screen, tap  at the top right of the screen.

New messages are displayed in the inbox. Tap on the e-mails to open them.

To reply to an e-mail

Tap  (Reply) or  (Reply to all), compose your message, and tap [SEND].

To forward an e-mail

Tap  (Forward), compose your forwarding message, and tap [SEND].

Deleting an e-mail

1. Put a check mark in the box of the e-mail you want to delete on the e-mail list screen, or open the e-mail and tap  at the top right of the screen.
2. Tap [OK].
The e-mail is deleted.

Related Topic

[Composing/Sending an E-mail](#)

[▶ Troubleshooting](#)

Preparations

Parts and Controls

Basic Operations

Connections

Other Operations



Apps

Announcements

Setting the Audio Output Sound

You can set the audio output sound to better enjoy music, videos, games, and more.

Sound settings include Sony-recommended [ClearAudio+], [Sound enhancements] that you can adjust as you would like, and [Dynamic normalizer].

1. Tap [ Apps & Widgets] - [ Settings] - [Sound].
2. Tap the desired setting from the following items.
 - [ClearAudio+]: Sony recommended sound settings for music optimize the settings of digital signal processing technology with just one touch.
 - [Sound enhancements]: Set the audio technologies your tablet device is equipped with or check which of those are being used. Those settings are not available when [ClearAudio+] is on. The items you can configure from the settings are as follows.
 - [Equalizer]: Set the sound quality suited for the genre of music.
 - [Clear Phase(TM)]: Set the sound quality suited for the built-in speakers.
 - [xLOUD(TM)]: Reproduce dynamic sound from the built-in speakers. This setting is not available when [S-Force Front Surround 3D] is on.
 - [S-Force Front Surround 3D]: Re-create a surround 3D sound field virtually.
 - [Dynamic normalizer]: Minimize volume differences between content. For example, this setting can prevent songs from playing back too loud or too quiet when you play back songs at random from multiple albums with different recording volumes.

Note

- [S-Force Front Surround 3D], [xLOUD(TM)], and [Dynamic normalizer] are not available while using some voice communications apps.
- [ClearAudio+], [Sound enhancements], and [Dynamic normalizer] are not supported with devices connected via Bluetooth or Multi Port.

Related Topic

[Changing the Settings](#)

▶ Troubleshooting

Using the “App Selector” with the tablet device attached to the Dock Speaker

Preparations

Parts and Controls

Basic Operations

Connections

Other Operations

Apps

Announcements

The App Selector starts automatically when you attach the tablet device to the Dock Speaker (SGPSPK1, sold separately).

With the App Selector, you can use the remote commander supplied with the Dock Speaker to select or operate apps.



Display on the screen		Description
1	Apps available when your tablet device is connected to the Dock Speaker	You can start or operate the apps using the remote commander supplied with the Dock Speaker.
2	Option menu	Adds/removes the apps that are available when your tablet device is connected to the Dock Speaker, changes order of the apps, or changes the App Selector settings.

Hint

- For details such as the procedures to connect the tablet device or operate the remote commander, refer to the Operating Instructions of the Dock Speaker.
- You can start the App Selector by pressing the HOME button on the remote commander even if you have selected  (Option menu) - [Settings] - [App Selector launch settings] - [Do nothing]. You can also continue using a running app if you connect your tablet device to the Dock Speaker while that app is running.

Note

- Update your tablet device to the latest version of Android when you use the App Selector [\[Details\]](#).
- You cannot start the App Selector from the remote commander when your tablet device is locked with [Pattern], [PIN] or [Passwords]. In this case, unlock your tablet device before using the remote commander.
- The Dock Speaker does not output sound when you connect the tablet device to the Dock

Speaker while the tablet device is muted. In this case, unmute the tablet device.

- The settings of [ClearAudio+], [Sound enhancements] and [Dynamic normalizer] do not affect to the output sound from the Dock Speaker [\[Details\]](#).
- Some apps cannot be operated with the remote commander.
- The Dock Speaker may not be available in some countries/regions.

Unmute the tablet device automatically when connected to the Dock Speaker

You can set the tablet device to output sound from the Dock Speaker even if you connect the tablet device to the Dock Speaker while muted.

1. Tap  (Option menu) - [Settings] - [What to do when the tablet is muted].
2. Tap [Unmute the tablet automatically].

Note

- If you select this setting, the tablet device will be unmuted and will remain unmuted even if you disconnect the tablet device from the Dock Speaker.
-

▶ [Troubleshooting](#)

[Preparations](#)

[Parts and Controls](#)

[Basic Operations](#)

[Connections](#)

[Other Operations](#)

[Apps](#)

[Announcements](#)

Notes on Using the Bluetooth Function

- Use of Bluetooth function may be restricted by local regulations in some countries or regions.
- The Bluetooth function may not work with some devices, depending on the manufacturer or the software version employed by the manufacturer. Check the system requirements of the Bluetooth device before purchasing.
Some Bluetooth devices require authentication (pairing) before establishing a connection with another device. Perform the authentication process before connecting to such a device.
- Bluetooth devices work on the 2.4 GHz band, which is used by a variety of devices. Bluetooth devices use technology to minimize radio interference from other devices that use the same band. However, radio interference may still cause slower data transfer speeds, reduce communications range or cause communications failure.
- Data transfer speed and communications range may vary depending on the following conditions:
 - Distance between communicating devices
 - Presence of obstacles between devices
 - Surrounding environment (wall material, etc.)
 - Device configuration
 - Software in use
 - Signal conditions
- Communications failure may occur in some signal conditions.
- Interference may occur if both the Bluetooth function and the 2.4 GHz Wi-Fi function are enabled. That will result in slower data transfer speeds or other problems.
- Large files may occasionally be corrupted during continuous transfer due to limitations of the Bluetooth standard and due to signal conditions.
- Connecting multiple Bluetooth devices to your tablet device may cause channel congestion, resulting in poor device performance. This is normal with Bluetooth technology and does not indicate a malfunction.
- Video and audio may not be synchronized if you play videos on your tablet device with audio output from a connected Bluetooth device. This is a frequent occurrence with Bluetooth technology and does not indicate a malfunction.
- All Bluetooth devices must be certified through procedures stipulated by Bluetooth SIG to ensure that they comply with the Bluetooth standard. Even if the Bluetooth standard is complied with, operation procedures may differ or you may not be able to transfer data depending on characteristics and specifications of the individual device.
- Output sound may not be switched between a Bluetooth audio device and the built-in speaker when you connect or disconnect the device while an app such as game is running. If that occurs, exit the app and restart the device. You can avoid this problem by switching the sound before starting the app.
- Sound of apps such as games may be delayed when heard from Bluetooth audio devices connected to your tablet device. If that occurs, output sound from the built-in speaker or connect an audio device to the headphone jack of your tablet device to hear the sound.
- If you turn off a Bluetooth audio device connected to your tablet device while an app such as a game is running, the app may no longer work properly. If that occurs, exit the app and restart your tablet device.

Bluetooth security

Bluetooth wireless technology has an authentication function that allows you to determine with whom you choose to communicate. With the authentication function, you can prevent any anonymous Bluetooth devices from accessing your tablet device. The first time two Bluetooth devices communicate, a common passkey (a password required for authentication) should be determined for both devices to be registered. Once a device is registered, there is no need to re-enter the passkey.

Your tablet device will be detected by other Bluetooth devices only when it is set to allow detection by such devices. You can set how long your tablet device is detectable or whether or not to allow reception after a connection is established.

Related Topic

[Specifications](#)

▶ Troubleshooting

Preparations

Parts and Controls

Basic Operations

Connections

Other Operations

Apps

Announcements

Backing Up Data on Your Tablet Device

You should copy the data in your tablet device and store it on another storage device (backup). Various data such as recorded images, downloaded music and video content will accumulate in your tablet device as you use them. If unexpected problems occur with your tablet device, that data may be damaged or lost. As a preventive measure in case of such accidents, you should make frequent backups so you will be able to restore your important data.

Note

- Some data on your tablet device cannot be backed up.
- Some settings and applications may not have any backup method. Make written notes and keep them in a safe place.

Data you can back up

You can copy and store the following data with your tablet device for backup.



- Music/movie/eBook files without copyright protection
- Pictures/wallpapers

That data is stored in the following folders.

- Music files: \Music
- Wallpaper files: \Pictures
- Movie files: \Movie
- Picture files: \DCIM
- eBook files: \Reader

Backing up data (copying)

Use the File transfer app to store the data on a commercially available SD memory card.

1. Tap  Apps & Widgets] followed by  File transfer] to start the File transfer app.
2. Insert the SD memory card into the SD card slot.
3. Select the file/folder you want to copy from your tablet device.
4. Tap .

A folder called “\transferred” is created on the SD memory card, and the data is copied to that folder.

Note

- Since video content purchased at Video Unlimited*¹ is copyrighted, you cannot back it up by the above mentioned method. Copy it on a computer using “Media Go” computer software. Go here to learn more about the Media Go application.

<http://mediago.sony.com/enu/introduction/>

*1 Video Unlimited is a video service available on Sony Entertainment Network.

Related Topic

[Checking the Free Space](#)

[Importing/Exporting Contents from an SD Memory Card](#)

[▶ Troubleshooting](#)

Preparations

Parts and Controls

Basic Operations

Connections

Other Operations

Apps

Announcements

Connecting to an HDMI Compatible Device

Your tablet device can output data to HDMI compatible devices such as a TV or projector. An HDMI adapter cable (sold separately) is necessary for this connection.

1. Turn over your tablet device, and then remove the Multi Port cover.
2. Connect the HDMI adapter cable (SGPHC1, sold separately) to the Multi Port.
3. Connect a commercially available HDMI cable to the HDMI adapter cable, and then connect to a TV or projector.
4. Connect the supplied USB cable for Multi Port (SGPUC2) to the HDMI adapter cable, and then connect to the AC adapter.

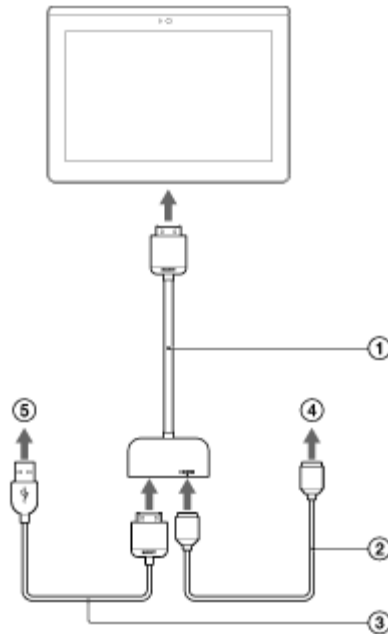

- ① HDMI Adapter Cable (SGPHC1, sold separately)
- ② Commercially available HDMI cable
- ③ Supplied USB cable for Multi Port (SGPUC2)
- ④ To TV or projector
- ⑤ To AC adapter

Hint

- For details on the HDMI adapter cable, see the operating instructions supplied with the HDMI adapter cable.

Related Topic

[Supported Formats](#)[Connecting to a Computer](#)

[▶ Troubleshooting](#)

[Preparations](#)

[Parts and Controls](#)

[Basic Operations](#)

[Connections](#)

[Other Operations](#)

[Apps](#)

[Announcements](#)

Compatibility of SD Memory Cards

SD memory cards (up to 2 GB), SDHC memory cards (up to 32 GB), SDHC UHS-I memory cards (up to 32 GB), SDXC memory cards (up to 64 GB), and SDXC UHS-I memory cards (up to 128 GB) available as of December 2012 have been tested and found compatible with your tablet device. However, this does not guarantee that all SD memory cards, SDHC memory cards, SDHC UHS-I memory cards, SDXC memory cards, or SDXC UHS-I memory cards will be compatible with your tablet device.

[▶ Troubleshooting](#)

[Preparations](#)

[Parts and Controls](#)

[Basic Operations](#)

[Connections](#)

[Other Operations](#)

[Apps](#)

[Announcements](#)

Notes on SD Memory Cards

- Keep away from infants. SD memory cards are harmful if swallowed.
 - Do not touch the contacts with fingers or metal objects.
 - SD memory cards contain delicate electronic components. Do not subject them to excessive force, bend or drop them.
 - Do not disassemble or modify.
 - Avoid moisture.
 - Do not use or store in the following locations:
 - Places with high temperature, such as inside a closed car in the sunshine
 - Places exposed to direct sunlight
 - Humid or corrosive environments
 - Excessively dusty places
 - Be sure to use SD memory cards that are compliant with the standards supported by your tablet device. A card of the wrong size may become jammed in the slot, causing damage to your tablet device.
 - You cannot write data to an SD memory card that is write-protected.
 - It is recommended that you make a backup copy of important data.
 - To avoid losing stored data, keep SD memory cards away from static electricity or electrical noise that may interfere with the card.
 - When carrying SD memory cards, be sure to put them in their case to avoid static electricity damage.
 - Before using an SD memory card with a device other than a tablet device, such as a digital camera or a portable audio player, format (initialize) the SD memory card using that device. Some devices may not support the file format for tablet devices and show you a message that recommends you to format the card. If you encounter such a message, copy data from the card to your tablet device (or to other devices via the network) and format the card using a device other than the tablet. Note that formatting a card will delete all current data contained on it. For more details, refer to the manual of the device you are using.
 - Do not insert foreign objects into the SD memory card slot.
 - The SD memory card slot can be used for reading/writing supported cards only, and it cannot be used for other purposes.
-

▶ [Troubleshooting](#)

[Preparations](#)

[Parts and Controls](#)

[Basic Operations](#)

[Connections](#)



[Other Operations](#)

[Apps](#)

[Announcements](#)



Grouping/Joining Contacts

Registering groups

1. Tap [GROUPS] at the top left of the screen, and then tap .
If you have multiple accounts, tap the account you want to register the group to.
2. Input the group's name, and then type the name of the person you want to be included.
3. Tap [ DONE].
The group is registered.

Joining contacts

You can join the contacts of a person who has two or more e-mail address, etc. and has been registered to separate contacts.

1. Tap [ALL] at the top left of the screen.
 2. Tap one of his/her contacts, and then tap  at the top right of the displayed screen.
 3. Tap  (Option menu) - [Join].
 4. Tap the contact you wish to join with.
The contact selected in step 4 is joined with the contact selected in step 2. The contact name after joining the contacts will be that of the contact selected in step 2.
-

[▶ Troubleshooting](#)

[Preparations](#)

[Parts and Controls](#)

[Basic Operations](#)

[Connections](#)

[Other Operations](#)

[Apps](#)

[Announcements](#)

Notes on GPS Function

- Move your tablet device as little as possible in an area with a clear view of the sky until the present location is displayed by the GPS function. The present location can be displayed quicker when stationary than while moving. If the present location is not displayed or if the wrong location is displayed, move to an area with a clear view of the sky.
 - Direction may not be measured correctly due to the surrounding environment.
 - When other electronic devices are near your tablet device, electromagnetic waves or magnetic interference from those may prevent your tablet device from providing accurate location information. Keep electronic devices away from your tablet device.
 - When your tablet device is in an area with poor reception of GPS signals, you may encounter positioning errors. To receive more accurate information, avoid using your tablet device in the following locations.
 - Inside buildings or vehicles
 - In tunnels or underground
 - Under elevated tracks
 - Between tall buildings
 - In dense trees
 - In valleys
-

[▶ Troubleshooting](#)

[Preparations](#)

[Parts and Controls](#)

[Basic Operations](#)

[Connections](#)

[Other Operations](#)

[Apps](#)

[Announcements](#)

Notes on Using Voice Communications Apps (SGPT13)

- When you attempt to use Internet telephone or voice chat over mobile network, you may not be able to establish a connection. Use Wi-Fi instead.
-

▶ [Troubleshooting](#)[Preparations](#)[Parts and Controls](#)[Basic Operations](#)[Connections](#)[Other Operations](#)[Apps](#)[Announcements](#)

Trademarks

- “Xperia” and “Xperia Tablet” are trademarks of Sony Mobile Communications AB.
- “Clear Phase,” “Clear Bass” and “xLOUD” are trademarks of Sony Corporation.
- “Reader” and the “Reader” logo are trademarks of Sony Corporation.
- Sony Electronics Inc., Sony and the Sony logo are trademarks of Sony Corporation.
- “PlayMemories Online” and “Sony Select” are trademarks of Sony Corporation.
- “Sony Entertainment Network logo” and “Sony Entertainment Network” are trademarks of Sony Corporation.
- “PlayStation” is a registered trademark or a trademark of Sony Computer Entertainment Inc.
- Google, Android platform, Gmail webmail service, Google+, Google Latitude location service, Google Maps mapping service, Google Places business listings, Google Search, Google Talk instant messaging service, Google Translate translation service, Google Drive online storage service, Google Books service and YouTube video community are trademarks of Google Inc.
- Adobe Flash Player Copyright(C) 1996-2011 Adobe Systems Incorporated. All rights reserved. Adobe and Flash are either registered trademarks or trademarks of Adobe Systems Incorporated in the United States and/or other countries.
- THIS PRODUCT IS LICENSED UNDER THE AVC PATENT PORTFOLIO LICENSE FOR THE PERSONAL AND NON-COMMERCIAL USE OF A CONSUMER TO
 - ENCODE VIDEO IN COMPLIANCE WITH THE AVC STANDARD (“AVC VIDEO”) AND/OR
 - DECODE AVC VIDEO THAT WAS ENCODED BY A CONSUMER ENGAGED IN A PERSONAL AND NON-COMMERCIAL ACTIVITY AND/OR WAS OBTAINED FROM A VIDEO PROVIDER LICENSED TO PROVIDE AVC VIDEO. NO LICENSE IS GRANTED OR SHALL BE IMPLIED FOR ANY OTHER USE. ADDITIONAL INFORMATION MAY BE OBTAINED FROM MPEG LA, L.L.C. SEE [HTTP://MPEGLA.COM](http://MPEGLA.COM)
- Bluetooth is a trademark or a registered trademark of Bluetooth SIG Inc. and any use of such mark by Sony is under license.
- “Crackle” and the Crackle logo are trademarks of Crackle, Inc.
- Evernote and the Evernote elephant logo are the trademarks of Evernote Corporation.
- Facebook, the Facebook logo, and the F logo are trademarks or registered trademarks of Facebook, Inc.
- (C) 2011 Gameloft. All rights reserved. Gameloft and the Gameloft logo are trademarks of Gameloft in the U.S. and/or other countries.
- iWnn (C) OMRON SOFTWARE Co., Ltd. 2008-2011 All Reserved.
- This software is based in part on the work of the Independent JPEG Group.
- MPEG Layer-3 audio coding technology and patents licensed from Fraunhofer IIS and Thomson.
- THIS PRODUCT IS LICENSED UNDER THE MPEG4 PATENT PORTFOLIO LICENSE FOR THE PERSONAL AND NON-COMMERCIAL USE OF A CONSUMER TO
 - ENCODE VIDEO IN COMPLIANCE WITH THE MPEG4 STANDARD (“MPEG4 VIDEO”) AND/OR
 - DECODE MPEG4 VIDEO THAT WAS ENCODED BY A CONSUMER ENGAGED IN A PERSONAL AND NON-COMMERCIAL ACTIVITY AND/OR WAS OBTAINED FROM A VIDEO PROVIDER LICENSED TO PROVIDE MPEG4 VIDEO. NO LICENSE IS GRANTED OR SHALL BE IMPLIED FOR ANY OTHER USE. ADDITIONAL INFORMATION MAY BE OBTAINED FROM MPEG LA, L.L.C. SEE [HTTP://MPEGLA.COM](http://MPEGLA.COM)
- (C) 2012 NVIDIA Corporation. All rights reserved. NVIDIA, the NVIDIA logo and Tegra are

trademarks and/or registered trademarks of NVIDIA Corporation in the U.S. and other countries.

- SD, SDHC and SDXC Logos are trademarks of SD-3C, LLC.



- TinyURL is a trademark or registered trademark of TinyURL, LLC.
- Twitpic is a trademark or registered trademark of Twitpic, Inc.
- The Twitter name, logo, Twitter T, Tweet, and Twitter bird are trademarks of Twitter, Inc. in the United States and other countries.
- THIS PRODUCT IS LICENSED UNDER THE VC-1 PATENT PORTFOLIO LICENSE FOR THE PERSONAL AND NON-COMMERCIAL USE OF A CONSUMER TO
 - (i) ENCODE VIDEO IN COMPLIANCE WITH THE VC-1 STANDARD (“VC-1 VIDEO”) AND/OR
 - (ii) DECODE VC-1 VIDEO THAT WAS ENCODED BY A CONSUMER ENGAGED IN A PERSONAL AND NON-COMMERCIAL ACTIVITY AND/OR WAS OBTAINED FROM A VIDEO PROVIDER LICENSED TO PROVIDE VC-1 VIDEO.NO LICENSE IS GRANTED OR SHALL BE IMPLIED FOR ANY OTHER USE. ADDITIONAL INFORMATION MAY BE OBTAINED FROM MPEG LA, L.L.C. SEE [HTTP://WWW.MPEGLA.COM](http://www.mpegla.com)
- Wi-Fi, the Wi-Fi CERTIFIED logo, WPA, WPA2 and Wi-Fi Protected Setup are trademarks or registered trademarks of Wi-Fi Alliance.
- Windows Media is either a registered trademark or trademark of Microsoft Corporation in the United States and/or other countries.
- Yfrog is a trademark or registered trademark of ImageShack Corp.
- (C) 2001-2011 Zinio LLC. - San Francisco - New York - London - Barcelona - Taipei - All rights reserved.
- Microsoft, Outlook, Exchange and ActiveSync are registered trademarks or trademarks of Microsoft Corporation in the United States and/or other countries.
“Microsoft Exchange ActiveSync” in the Implementation user interface where appropriate
“Microsoft(R) Exchange ActiveSync(R)” for any printed material (including packaging, literature, marketing materials and advertising)
- (C) 2012 Anne Gutman & Georg Hallensleben / Hachette Livre
- TrackID(TM) is powered by Gracenote(TM) Mobile MusicID(TM). Gracenote, Mobile MusicID, and Video Explore are trademarks or registered trademarks of Gracenote, Inc.
- The product utilizes Japanese handwriting recognition technology, LaLaStroke provided by TOSHIBA Corporation.
LaLaStroke is a trademark of TOSHIBA Corporation.
- (R) MobiSystems 2012
- RealFeel(R) - AccuWeather’s proprietary weather forecasting system that takes into account multiple weather conditions to determine how the local temperature actually feels, which may be warmer or colder than the temperature depending on these conditions.
- The Skype name, associated trade marks and logos and the “S” logo are trade marks of Skype or related entities.
- Hulu, the Hulu logo, www.hulu.com, and other Hulu marks, graphics, logos, scripts, and sounds are trademarks of Hulu. None of the Hulu trademarks may be copied, downloaded, or otherwise exploited.
- Netflix is a trademark or a registered trademark of Netflix, Inc.
- NetMovies, Filmes e Séries à vontade
- http://www.totalmovie.com/page.php?id=terms_and_conditions
- The terms HDMI and HDMI High-Definition Multimedia Interface, and the HDMI Logo are trademarks or registered trademarks of HDMI Licensing LLC in the United States and other countries.

All other names of systems, products, and services are trademarks or registered trademarks of their respective owners. In this manual, the (TM) or (R) marks are not specified.

© 2012 Sony Corporation



[▶ How to Use](#)

Network / Internet

Tablet Device

Apps

GPS

The results of GPS positioning are different from the actual location.

Your tablet device cannot receive GPS signals or takes a long time for positioning.



▶ [How to Use](#)

Network / Internet

Tablet Device

Apps

Wi-Fi

Your tablet device cannot connect to a Wi-Fi network.

[▶ How to Use](#)

[Network / Internet](#)[Tablet Device](#)[Apps](#)

Battery

Battery consumption increases.

Heat builds up in the tablet device and the AC adapter while the tablet device is in use or being charged.

The battery does not charge.

The charge indicator blinks.

The charge indicator does not appear.

▶ [How to Use](#)

[Network / Internet](#)

[Tablet Device](#)

[Apps](#)

Display

[Some points on the screen are not displayed properly.](#)

[The screen brightness cannot be adjusted.](#)

[The screen brightness does not adjust automatically as expected.](#)

[The screen brightness is not stable.](#)

[The screen disappears/darkens unexpectedly.](#)

[The screen does not rotate when you turn your tablet device.](#)

[The screen is dark.](#)

[The touch screen does not work as expected.](#)

[You want to turn off screen rotation.](#)



▶ [How to Use](#)

[Network / Internet](#)

[Tablet Device](#)

[Apps](#)

Power

[The tablet device does not turn on.](#)

[The tablet device starts up slowly.](#)

[▶ How to Use](#)

[Network / Internet](#)[Tablet Device](#)[Apps](#)

Sound

The sound from the built-in speaker is interrupted when the screen is rotated.

The sound from the speaker is distorted.

You want to turn off the tap sound (operation sound).

You might be looking for the following topics:

[You cannot use Internet telephone or voice chat. \(SGPT13\)](#)



[▶ How to Use](#)

Network / Internet

Tablet Device

Apps

Bluetooth

A Bluetooth(R) device was not found.

[▶ How to Use](#)

[Network / Internet](#)[Tablet Device](#)[Apps](#)

Main unit

Heat builds up in the tablet device and the AC adapter while the tablet device is in use or being charged.

Your tablet device becomes slow or is not performing as expected.

Your tablet device does not work.

[▶ How to Use](#)

[Network / Internet](#)[Tablet Device](#)[Apps](#)

Settings

The date and time are reset.

You want to deactivate the lock screen function/use your tablet device without locking the screen.

Your tablet device needs to be reset.

You might be looking for the following topics:

[Some applications are not displayed in the selected language.](#)

[Some applications cannot be uninstalled.](#)



[▶ How to Use](#)

Network / Internet

Tablet Device

Apps

Browser

[A website for mobile phones or smartphones is displayed.](#)



[▶ How to Use](#)

Network / Internet

Tablet Device

Apps

File

A file cannot be displayed or does not play.



[▶ How to Use](#)

[Network / Internet](#)

[Tablet Device](#)

[Apps](#)

Images

The video is interrupted/is jumpy/is not synchronized with the audio.

[▶ How to Use](#)

[Network / Internet](#)

[Tablet Device](#)[Apps](#)

Settings

[Some applications are not displayed in the selected language.](#)

[Some applications cannot be uninstalled.](#)

You might be looking for the following topics:

[The date and time are reset.](#)

[You want to deactivate the lock screen function/use your tablet device without locking the screen.](#)

[Your tablet device needs to be reset.](#)



[▶ How to Use](#)

Network / Internet

Tablet Device

Apps

Camera

[The photos and movies taken with the camera are blurry.](#)



[▶ How to Use](#)

[Network / Internet](#)

[Tablet Device](#)

[Apps](#)

GPS

The results of GPS positioning are different from the actual location.

Your tablet device cannot receive GPS signals or takes a long time for positioning.



[▶ How to Use](#)

Network / Internet

Tablet Device

Apps

Remote control

The Remote control app will not learn certain operations.

[▶ How to Use](#)

[Network / Internet](#)

[Tablet Device](#)

[Apps](#)

Sound

The sound from the built-in speaker is interrupted when the screen is rotated.

The sound from the speaker is distorted.

You cannot use Internet telephone or voice chat. (SGPT13)

You might be looking for the following topics:

[You want to turn off the tap sound \(operation sound\).](#)

[▶ How to Use](#)

[Network / Internet](#)

[Tablet Device](#)

[Apps](#)

The results of GPS positioning are different from the actual location.

Move to an area with good reception of GPS signals and with a clear view of the sky [\[Details\]](#).

[▶ How to Use](#)

Network / Internet

Tablet Device

Apps

Your tablet device cannot receive GPS signals or takes a long time for positioning.

Move to an area with good reception of GPS signals and with a clear view of the sky [\[Details\]](#).

▶ [How to Use](#)

[Network / Internet](#)

[Tablet Device](#)

[Apps](#)

Your tablet device cannot connect to a Wi-Fi network.

Make sure the Wi-Fi function is turned on.

- Tap [ Apps & Widgets] - [ Settings] - [Wi-Fi] in that order, and then set [Wi-Fi] to [ON].

Make sure there is not anything blocking the signal between devices and that the devices are not too far away from each other [\[Details\]](#).

Check the Wi-Fi connection by using the Wi-Fi checker app [\[Details\]](#).

You may be able to make a connection by changing the channel settings of your access point.

Make sure the [Network SSID] and the [Security] of your access point are set correctly.

[▶ How to Use](#)

[Network / Internet](#)

[Tablet Device](#)

[Apps](#)

Battery consumption increases.

The battery may be deteriorated.

- Contact the service/support center named in the warranty to replace the battery.
-

[▶ How to Use](#)

Network / Internet

Tablet Device

Apps

Heat builds up in the tablet device and the AC adapter while the tablet device is in use or being charged.

Heat buildup while the tablet device is in use or being charged is normal and should not affect the performance of your tablet device.

The tablet device may shut down for safety when overheated. If this happens, use the tablet device in a cool area until it cools down.

If your tablet device becomes abnormally hot, it may be in need of repair. Turn off your tablet device, and stop using the the AC adapter and tablet device. Contact the service/support center named in the warranty.

[▶ How to Use](#)

[Network / Internet](#)

[Tablet Device](#)

[Apps](#)

The battery does not charge.

Make sure you have securely connected the tablet device with the USB cable for Multi Port, the USB cable for Multi Port with the AC adapter, the AC adapter with an AC power cord (mains lead), and an AC power cord (mains lead) with an AC outlet (wall socket).

* You do not need an AC power cord (mains lead) in some countries.

If the temperature of the tablet device rises in situations such as while using apps (Browser, Email, Camera, or playing videos/music), the battery may not be charged. If the temperature rises, shut down the running apps. The battery will begin to charge when the tablet device returns to normal temperature.

Your tablet device does not support charging the battery via USB connection from a computer or a commercially available charger not designated by Sony.



▶ [How to Use](#)

Network / Internet

Tablet Device

Apps

The charge indicator blinks.

The charge indicator blinks slowly (every 3 seconds) when the remaining battery level is 15% or less. Plug in your tablet device and charge the battery [\[Details\]](#).

- The charge indicator does not blink while your tablet device is turned off, even if the remaining battery level is 15% or less.

When the charge indicator blinks fast (every 0.5 seconds), your tablet device may be in need of repair. Stop using the tablet device and contact the service/support center named in the warranty.

[▶ How to Use](#)

[Network / Internet](#)

[Tablet Device](#)

[Apps](#)

The charge indicator does not appear.

Make sure you have securely connected the tablet device with the USB cable for Multi Port, the USB cable for Multi Port with the AC adapter, the AC adapter with an AC power cord (mains lead), and an AC power cord (mains lead) with an AC outlet (wall socket).

* You do not need an AC power cord (mains lead) in some countries.

Your tablet device does not support charging the battery via USB connection from a computer or a commercially available charger not designated by Sony. Charge the battery using the supplied AC adapter or designated Sony AC adapter.

[▶ How to Use](#)

[Network / Internet](#)

[Tablet Device](#)

[Apps](#)

Some points on the screen are not displayed properly.

You may see tiny black points on the LCD screen on rare occasions. This does not indicate a malfunction [\[Details\]](#).

[▶ How to Use](#)



[Network / Internet](#)

[Tablet Device](#)

[Apps](#)

The screen brightness cannot be adjusted.

When the screen brightness is set to adjust automatically, you cannot adjust the screen brightness manually.

- Tap [ Apps & Widgets] - [ Settings] - [Display] - [Brightness] - [Automatic brightness] to remove the check mark and disable the automatic brightness setting.
-

[▶ How to Use](#)

[Network / Internet](#)

[Tablet Device](#)

[Apps](#)

The screen brightness does not adjust automatically as expected.

When you set the screen brightness to adjust automatically, the screen will not darken once it gets brighter. This does not indicate a malfunction. Brightness returns to normal when you press the power button to turn off the screen (switch to sleep mode) and press it again to turn the screen back on.

[▶ How to Use](#)



[Network / Internet](#)

[Tablet Device](#)

[Apps](#)

The screen brightness is not stable.

When you set the screen brightness to adjust automatically, the screen brightness will adjust according to the surrounding light.

- Tap [ Apps & Widgets] - [ Settings] - [Display] - [Brightness] - [Automatic brightness] to remove the check mark and disable the automatic brightness setting.
-

[▶ How to Use](#)



[Network / Internet](#)

[Tablet Device](#)

[Apps](#)

The screen disappears/darkens unexpectedly.

The screen goes to sleep automatically after a certain period of time to reduce battery consumption.

- The screen turns on again when you push the power button.
 - When you want to change the time before the screen goes to sleep, tap [ Apps & Widgets] - [ Settings] - [Display] - [Sleep] in that order to set the time.
 - If you set the time to a longer interval before going to sleep, the battery will be consumed faster.
-

[▶ How to Use](#)

[Network / Internet](#)

[Tablet Device](#)

[Apps](#)

The screen does not rotate when you turn your tablet device.

Some applications may not support screen rotation. This does not indicate a malfunction.

[▶ How to Use](#)

[Network / Internet](#)

[Tablet Device](#)

[Apps](#)

The screen is dark.



Make sure the screen brightness of your tablet device is not set at the lowest level.

Make sure the remaining battery level is sufficient.

Be careful not to cover the ambient light sensor.

The screen may seem dark if used outdoors on a clear day.

If you have the automatic brightness setting enabled, the brightness of the screen is adjusted automatically according to the surrounding brightness.

- Tap [ Apps & Widgets] - [ Settings] - [Display] - [Brightness] - [Automatic brightness] to remove the check mark and disable the automatic brightness setting.
-

[▶ How to Use](#)

[Network / Internet](#)

[Tablet Device](#)

[Apps](#)

The touch screen does not work as expected.

Make sure you are using the touch screen correctly [\[Details\]](#).

If the touch screen is damaged (scratched, etc.), contact the service/support center named in the warranty.

If the touch screen does not work, turn off your tablet device, and then turn it on again.

- If you cannot turn off your tablet device, press and hold the power button for about 10 seconds to force it to turn off, and then turn it on again [\[Details\]](#).
-



[▶ How to Use](#)

[Network / Internet](#)

[Tablet Device](#)

[Apps](#)

You want to turn off screen rotation.

Tap [ Apps & Widgets] - [ Settings] - [Display] - [Auto-rotate screen] to remove the check mark and turn off screen rotation.

▶ [How to Use](#)

[Network / Internet](#)

[Tablet Device](#)

[Apps](#)

The tablet device does not turn on.

The battery may be extremely low on power.

- Connect your tablet device to an AC outlet (wall socket), and charge the battery.

Your tablet device may be turned off completely.

- Press and hold the power button for three seconds to turn on your tablet device.

When your tablet device is using power supplied from the outlet, make sure you have securely connected the tablet device with the USB cable for Multi Port, the USB cable for Multi Port with the AC adapter, the AC adapter with an AC power cord (mains lead)*, and an AC power cord (mains lead) with an AC outlet (wall socket).

- When your tablet device is sitting in the cradle (sold separately), make sure you have securely connected the tablet device with the cradle, the cradle with the USB cable for Multi Port, the USB cable for Multi Port with the AC adapter, the AC adapter and an AC power cord (mains lead)*, and an AC power cord (mains lead) with an AC outlet (wall socket).

If you have not turned off your tablet device properly, the power supply controller may have stopped due to a program failure. Reset the tablet device by pressing and holding the power button for about 10 seconds, and then turn on the tablet device again [\[Details\]](#).

* You do not need an AC power cord (mains lead) in some countries.



▶ [How to Use](#)

Network / Internet

Tablet Device

Apps

The tablet device starts up slowly.

When you boot your tablet device with the power turned off, it may take some time to boot up.

[▶ How to Use](#)

[Network / Internet](#)

[Tablet Device](#)

[Apps](#)

The sound from the built-in speaker is interrupted when the screen is rotated.

The sound may be interrupted when the screen is rotated while using the built-in speaker. This does not indicate a malfunction.

[▶ How to Use](#)

[Network / Internet](#)

[Tablet Device](#)



[Apps](#)

The sound from the speaker is distorted.

Adjust the playback volume.

Make sure the tablet device is sufficiently charged.

If the sound effects are turned off, the sound might improve.

Tap [ Apps & Widgets] - [ Settings] - [Sound] - [Sound enhancements] - [Settings] - [xLOUD(TM)] or [Clear Phase(TM)] to remove the check mark from the box for that setting.



[▶ How to Use](#)

[Network / Internet](#)

[Tablet Device](#)

[Apps](#)

You want to turn off the tap sound (operation sound).

Tap [ Apps & Widgets] - [ Settings] - [Sound] - [Touch sounds] to remove the check mark and disable the tap sound.

Press and hold the VOL – (Volume) button of your tablet device until the volume indicator displayed on the screen minimizes and the icon reverses.



[▶ How to Use](#)

Network / Internet

Tablet Device

Apps

You cannot use Internet telephone or voice chat.
(SGPT13)

Use Internet telephone or voice chat with Wi-Fi.

▶ [How to Use](#)

[Network / Internet](#)

[Tablet Device](#)

[Apps](#)

A Bluetooth(R) device was not found.

Make sure the Bluetooth function of your tablet device is turned on.

- Tap [⋮] Apps & Widgets] - [⚙ Settings] - [Bluetooth], and then set [Bluetooth] to [ON].

Make sure the Bluetooth device you are pairing with is turned on.

When you tap [⋮] Apps & Widgets] - [⚙ Settings] - [Bluetooth] and then tap [SEARCH FOR DEVICES] at the top right of the screen, a Bluetooth device may not be found immediately. Possible reasons are the number of devices around your tablet device, the distance from the device, the environment, and signal conditions.

- Bring the Bluetooth device you are pairing with as close to your tablet device as possible, and try again.

Make sure the Bluetooth device you are pairing with is in discoverable mode.

- The Bluetooth function of the commercially available Bluetooth device you are pairing with should be turned on and should be in discoverable mode.
 - When you reconnect a disconnected Bluetooth device that was previously connected to your tablet device, connect the Bluetooth device again after deleting registration by both the Bluetooth device and the tablet device.
-

[▶ How to Use](#)

[Network / Internet](#)

[Tablet Device](#)

[Apps](#)

Your tablet device becomes slow or is not performing as expected.

Your tablet device may slow down when you use it in a hot or cold environment. Use the tablet device in a place with a suitable temperature as much as possible.

If your tablet device becomes slow or is not performing as expected, it may perform better if you turn it off once and then turn it back on.

If your tablet device's data storage area is full, this may cause your tablet device not to perform as expected.

- Uninstall any unnecessary applications.
-

[▶ How to Use](#)

[Network / Internet](#)

[Tablet Device](#)

[Apps](#)

Your tablet device does not work.

Press and hold the power button for about 10 seconds to force it to turn off, and then turn it on again [\[Details\]](#).

Contact the service/support center named in the warranty if this does not solve the problem.

[▶ How to Use](#)

[Network / Internet](#)

[Tablet Device](#)

[Apps](#)

The date and time are reset.

When the remaining battery power is extremely low, the date and time might be reset.

- Charge the battery, and then set the date and time again.
-



[▶ How to Use](#)

[Network / Internet](#)

[Tablet Device](#)

[Apps](#)

You want to deactivate the lock screen function/use your tablet device without locking the screen.

Tap [ Apps & Widgets] - [ Settings] - [Security] - [Screen lock], then tap [None] to deactivate the lock function.



[▶ How to Use](#)

[Network / Internet](#)

[Tablet Device](#)

[Apps](#)

Your tablet device needs to be reset.

Tap [ Apps & Widgets] - [ Settings] - [Backup & reset] - [Factory data reset], and then tap [Reset tablet] at the bottom of the menu on the right.

- All data in the data storage area is deleted, including the Google account information, the system data and settings, and any application data you have downloaded.
 - It is recommended that you make a backup copy of important data because the user data cannot be restored after being deleted.
 - The tablet device restarts automatically.
-

[▶ How to Use](#)

[Network / Internet](#)

[Tablet Device](#)

[Apps](#)

Some applications are not displayed in the selected language.

Some applications do not accommodate the language selected in the language settings of your tablet device and are displayed in a different language.

[▶ How to Use](#)

Network / Internet

Tablet Device

Apps

Some applications cannot be uninstalled.

Some applications cannot be uninstalled (deleted). This does not indicate a malfunction of the tablet device or a bug in the application.



[▶ How to Use](#)

Network / Internet

Tablet Device

Apps

A website for mobile phones or smartphones is displayed.

Some websites may be displayed in a layout for mobile phones or smartphones layout.

[▶ How to Use](#)

[Network / Internet](#)

[Tablet Device](#)

[Apps](#)

A file cannot be displayed or does not play.

The data may be damaged.

Make sure the file format of the data is supported by your tablet device [\[Details\]](#).

Make sure the file is of a format supported by the application.

▶ [How to Use](#)

Network / Internet

Tablet Device

Apps

The video is interrupted/is jumpy/is not synchronized with the audio.

Make sure the file is of a format supported by the application [\[Details\]](#).

Turn off your tablet device, and then turn it on again.

The data may be damaged.

Make sure that other apps are not doing processor intensive tasks in the background.



[▶ How to Use](#)

Network / Internet

Tablet Device

Apps

The photos and movies taken with the camera are blurry.

Make sure any condensation or dirt is removed from the lens or the cover of the camera.

[▶ How to Use](#)

[Network / Internet](#)

[Tablet Device](#)

[Apps](#)

The Remote control app will not learn certain operations.

Your tablet device may not be able to learn some remote control operations depending on the kind of IR remote control. This does not indicate a malfunction.

The IR data port of your tablet device may not be facing that of the remote control. Check the position of the IR data port of your tablet device, then try again to match the IR data ports of the tablet device and remote control at a distance of about 20 mm to 50 mm (0.8 in. to 2 in.)

[\[Details\]](#).
